

Las Ventanas Ranch Mutual Benefit Water Company

Technical Engineering Report for a Domestic Water System

June, 2008

Prepared by:

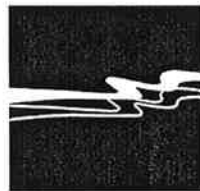

WALLACE GROUP

612 Clarion Court
San Luis Obispo, CA 93401
(805) 544-4011

Table of Contents

General Water System Information	4
Source Water Information	4
Treatment and Design Information.....	5
Distribution System Information	8
Operational Plans.....	8
Amendments to the Permit	9

List of Figures

Figure 1 - Site Map.....	7
--------------------------	---

List of Exhibits

- Exhibit A: Well Reports
- Exhibit B: Water System Calculations
- Exhibit C: Approved Construction Drawings
- Exhibit D: Sampling Station Plan
- Exhibit E: Domestic Water Supply Permit from San Luis Obispo County Health Department

LAS VENTANAS RANCH MUTUAL BENEFIT WATER COMPANY

In the County of San Luis Obispo

Engineer's Statement

The water supply, distribution, and fire protection system for the Las Ventanas Ranch Mutual Benefit Water Company system (Tract 2408 – Phase 2) in the County of San Luis Obispo will adequately, dependably, and safely meet the total requirements for all water consumers under maximum consumption as defined by the CC&Rs for the development, County of San Luis Obispo standards, County Health requirements, State Health requirements, and California Division of Forestry (CDF) requirements, and will meet the requirements of Section 14314.

Consent of Expert

I, Robert S. Miller, RCE 57474, hereby consent to the inclusion of, or reference to the Engineer's Report (Technical Report) and to the inclusion of my name in the prospectus or offering circular for the Las Ventanas Ranch Mutual Benefit Water Company system.



Robert S. Miller, RCE 57474

Certification appurtenant to Technical Report dated June, 2008



I. General Water System Information

Introduction: The Las Ventanas Ranch Mutual Benefit Water Company (Company) will be formed to service the residential needs of the east side of Tract 2408, Biddle Ranch East Development. Tract No. 2408 is located approximately 3 miles northeast of the city of Arroyo Grande in the San Luis Bay, Huasna, and San Luis Obispo Planning Areas.

Talley Farms is the developer of the 4,560-acre Biddle Ranch East Site, designated for agricultural use. This site includes 3,800 acres of open space.

Biddle Ranch East is located on the east side of Lopez Drive, south of Orcutt Road and includes 55 residential lots with an average size of 2.17 acres per lot. The project will use two on-site wells for water supply and individual septic systems for wastewater treatment and disposal.

Service Connections and Types of Service Connections: Biddle Ranch is comprised of 55 residential lots with an average size of 2.17 acres.

Type of Users: Biddle Ranch East will be limited to single-family lots. There will be no industrial or agricultural uses of water within the limits of Biddle Ranch East. The planning documents include a clause that requires drought tolerant plants to be used for planting outside of a 30-foot envelope surrounding buildings; and irrigation will likely be limited to within this envelope.

Consolidation Evaluation: The nearest public water system to Biddle Ranch East is the City of Arroyo Grande. The distance between Biddle Ranch East and City of Arroyo Grande is 3 miles. It was deemed impractical to connect Biddle Ranch East with the City because the cost of running a supply main would be greater than forming a decentralized supply system. In addition, the operational logistics of monitoring and maintaining the satellite system would be more costly than creating a separate mutual water company.

Map of Facilities: Figure 1 shows a site plan of the Biddle Ranch East Development Project, including the proposed water distribution system. The location of the well, storage tank, and primary transmission lines are identified on Figure 1.

II. Source Water Information

Description of Source and Water Rights: Biddle Ranch East's water comes exclusively from the Arroyo Grande Valley Sub Basin (AGVS) within the Santa Maria Groundwater Basin. Certain sub basins within the Santa Maria Groundwater Basin are in the process of being adjudicated, including Arroyo Grande Valley (though Arroyo Grande Valley continues to be unadjudicated). Talley Farms is in the process of converting 281 acres of vegetable cropland from furrow and sprinkler irrigation to drip irrigation to meet the domestic water demand without straining the groundwater resources of the AGVS. This conversion will save approximately 300 acre-feet of water per year, which more than compensates for the 14 acre-feet demand posed by Biddle Ranch East.

Water Quantity: Water supply for the Company consists of two wells located approximately 240 feet south of the covered bridge on the property and east of Lopez Drive. The wells are designated as Well A (primary) and Well B (secondary).

The primary well (Well A) was drilled on October 10, 2005. (State well number 2005-354). Well A was drilled to a completed depth of 140'; the static water level is 25' below the ground surface. The well has an 8-inch F480/PVC (SDR-21) casing to 80' and an 8-inch perforated F480/PVC (SDR-21) casing to 120'. The annular seal is cemented down to 50', and there is a pea gravel filter pack that extends from 50' to 140'. The well completion report indicates an estimated yield of greater than 500 gpm, though no pump test data is referenced. A Well Completion Report for this well is included as Exhibit A.

The secondary well (Well B) located approximately 168 ft south of Well A, was drilled on October 10, 1975. It was originally designated the Pennington Well. (State well number is not registered on the available drilling log). Well B was drilled to a completed depth of 80'; the static water level is 22' below the ground surface. The well has a 10-inch casing. The annular seal is cemented down to 35', and there is a pea gravel filter pack that extends from 35' to 80'. A Well Completion Report for this well is included as Exhibit A.

Biddle Ranch East is permitted for a maximum of 55 single-family residential lots, and an entry building. Drought tolerant plants are required to be used for landscaping in all public areas, except within a 30-foot envelope around residences. Calculations for water storage and supply water required by the Biddle Ranch East are collected in Exhibit B. These calculations were performed by the Wallace Group in accordance with the San Luis Obispo County Department of Public Works, "Standard Improvement Specifications and Drawings".

Assessment of Vulnerability to Contamination: A Drinking Water Source Assessment and Protection (DWSAP) Program Report is will completed in the future with the assistance of the County Health Department.

Water Quality: Water quality has been tested from each of the water supply wells. The water meets all requirements for primary drinking water standards. The well water also meets the recommended levels of the secondary drinking water standards. Provisions for future iron/manganese removal have been provided if needed. A chlorination system will be used to pre-treat the water.

III. Treatment and Design Information

Description and Layout Design Capacities: The domestic water supply system is comprised of two wells, each equipped with 120 gpm pumps, a 6-inch Class-350 Ductile Iron Pipe and a 6-inch Class-150 C900 dedicated supply line, sodium hypochlorite injection, two 166,000 gallon bolted steel tank (with 155,650 gallons of actual storage for each), and a gravity distribution system.

Well Construction: Well pumps were selected to meet the average daily demand of Biddle Ranch East as outlined in the San Luis Obispo County Standards. Based on 55 lots and one acre of parks and open space landscaping, the average daily demand of Biddle Ranch East will be approximately 22,400 gallons per day. One well pump, rated at 120 gpm, will supply the average daily demand in about 3 hours of pumping. Well pumps will meet the average daily residential flow for the maximum month (1/3 of the peak hourly residential) as required by SLO County Engineering Department. Proposed electrical service for the well pumps is oversized – for potential upgrades, if necessary.

Treatment Chemicals & Disinfection Facilities: Domestic water will be treated at the storage tank site, prior to entering the tank. Sodium hypochlorite will be used for disinfection prior to entering the storage tanks. The chemical feed will be able to meter sodium hypochlorite to flows up to the peak design flowrate of 220 gpm, with both wells in operation. The dose will be about 0.6 mg/L, and will be adjusted to obtain a 0.2 mg/L residual. The system will use less than 1 gallon of sodium hypochlorite per day. The layout of the treatment system is displayed on Sheet W-5 of the approved construction drawings.

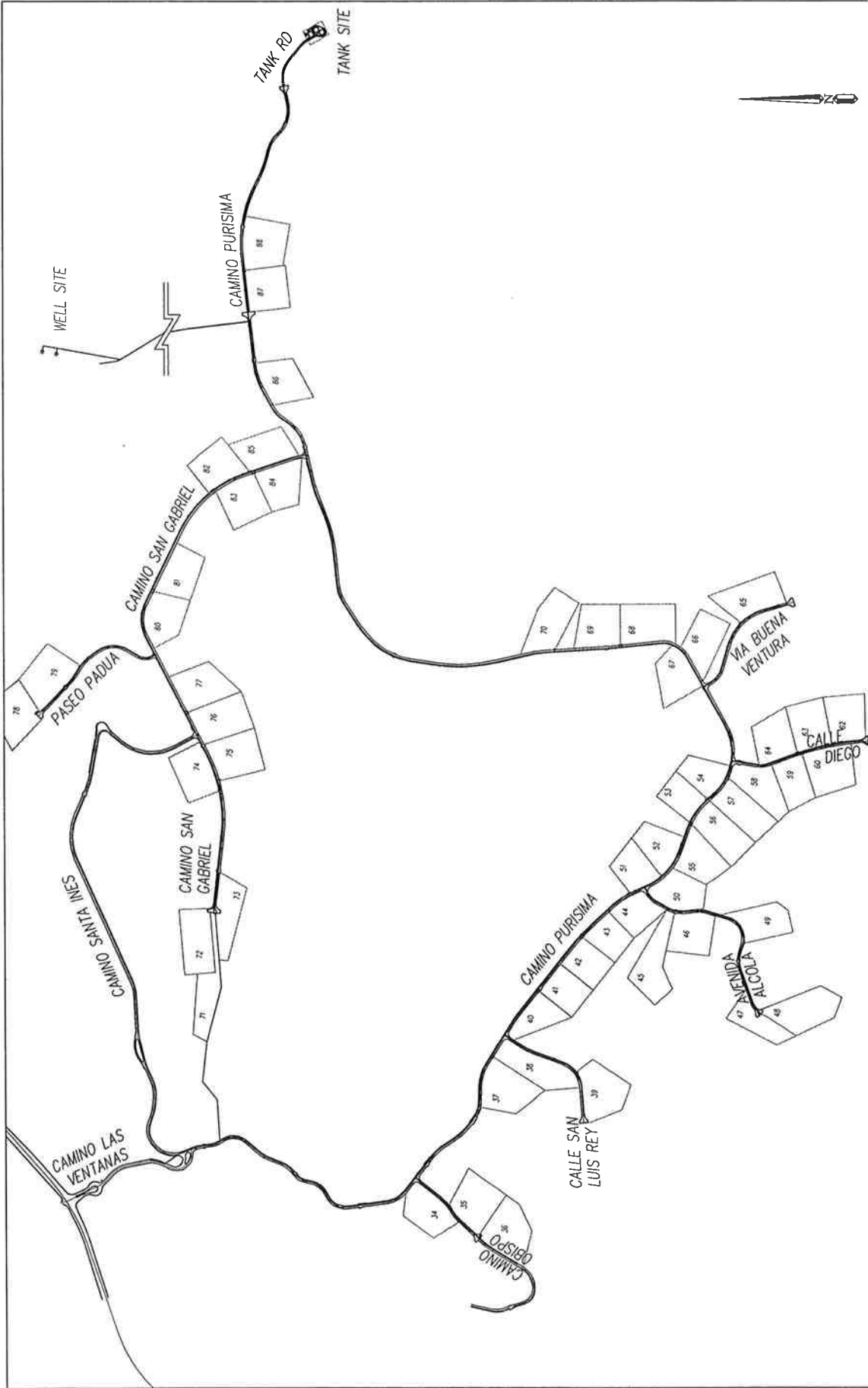

JOB No. : S014-0001
 DRAWING : SITE PLAN
 DRAWN BY: SLS
 DATE : 03-21-06
 SCALE : 1"=1000'

BIDDLE RANCH EAST CLUSTER
TRACT 2408
SITE PLAN

1330 ARNOLD DRIVE, SUITE 249
 MARTINEZ, CALIFORNIA 94553
 T 925 228-5801
 F 925 228-5804
 www.wallacegroup.us



WALLACE GROUP

IV. Distribution System Information

Location & Water Mains: Exhibit C displays an overview of the water distribution system. In addition, Sheet W-1 of the approved plans shows details of pipe sizes and materials for each pipe segment, pressure reducing station locations, and static pressures at each lot.

Water flows by gravity from the tank site to all lots at Biddle Ranch East. Due to the significant elevation drop across the site, four pressure reducing stations will be constructed, creating four distinct pressure zones.

Zone 1: All pipe segments between the tank site and PRV 2, on the eastern portion of the project site.

- Roads: Camino Purisima STN 67+28 to “end”, Tank Road, Calle Diego, and Via Buena Ventura.
- Lot 58, 59 to 70 & Lots 86 to 88.

Zone 2: All pipe segments between PRV 2 and PRV 3, on the south branch of the system.

- Roads: Camino Purisima STN 38+00 to 67+28, Calle San Luis Rey, and Avenida Alcola.
- Lots 37 to 57 (or 58)

Zone 3: All pipe segments between PRV 1 and PRV 4, on the north branch of the system.

- Roads: Camino San Gabriel and Paseo Padua.
- Lots 71 to 85

Zone 4: All pipe segments between PRV 3 and PRV 4, comprising the “loop” down to the entrance gate, on the western portion of the site.

- Roads: Camino Purisima STN 10+00 to 38+00, Camino Las Ventanas, Camino Obispo, and the non-road section from PRV 4 (near Lot 71) to Camino Purusima STN 10+00.
- Lots 34 to 36

Tables 1 & 2 in Exhibit C show residual pressures at hydrants and at lots following peak hour demand. Table 3 in Exhibit C lists the pipe materials for each segment of the distribution system.

Pumping Stations and Storage Tanks: Drawings (full size) of the wells and water storage were previously approved by the San Luis Obispo County Public Works Department and are on file with the Water Company. The distribution system will not have any pumping stations. Each of the two water storage tanks has 155,650 gallons of usable storage.

V. Operational Plans

A preliminary water quality monitoring plan for Biddle Ranch East is included in Exhibit D. Supplemental monitoring requirements will be issued periodically by the County Health Department.

VI. Environmental Documentation

An environmental document was previously approved for the project in accordance with CEQA. A copy of the San Luis Obispo County Planning Commission staff report is on file with the Water Company.

VII. Amendments to the Permit

An amendment to the water permit will be submitted if any of the following changes occur:

- Change in ownership of the water system
- The addition of new water sources
- Any changes in the method of treatment
- The addition of any storage reservoirs
- A major expansion of the service area
- Any change in the distribution system that does not comply with the waterworks standards

Exhibit A: Well Reports



April 12, 2006

Eileen Stephens
Wallace Group
1330 Arnold Drive, Suite 249
Martinez, California 94553

**SUBJECT: Well 1 and Well 2, Biddle Ranch–Phase II, Lopez Drive, Arroyo Grande, California.
(Well "A") (Well "B")**

Dear Ms. Stephens:

Cleath & Associates has completed the supervision and data collection of 72-hour constant rate discharge tests and recovery tests for Well 1 (New Well) and Well 2 (Old Well) for Biddle Ranch – Phase II. The wells are located on Pennington Ranch, Lopez Drive, Arroyo Grande, California. The 72-hour pump tests were performed simultaneously from March 20 to 23, 2006. Well 1 was pumped at an average rate of 200 gallons per minute (gpm) throughout the test and Well 2 was pumped at an average rate of 190 gpm throughout the test. The well locations are shown on Figure 1. Water quality samples were obtained by Cleath & Associates two hours after the start of the test and submitted to Creek Environmental Laboratory for analysis.

Well 1 (New Well)

Well 1 was drilled and constructed in October 2005 by Central Coast Drilling, Inc. The well was completed to a depth of 140 feet, and screened from 80 to 140 feet depth. The cement sanitary seal extends to 50 feet depth. The Well Completion Report is included in Appendix A.

Prior to the beginning of the pump test the static water level was measured at 25.98 feet below the top of the well casing. At the end of the test, the pumping water level was 27.35 feet below the top of the well casing. Water levels dropped a total of 1.37 feet during the test. A 55-minute recovery test was conducted at the well following the pump test, beginning when the pump was shut off. During this time water levels recovered to 26.16 feet below the top of the casing, or within 0.18 feet of the static water level. The pump test data and graphs are included in Appendix B.

Water Quality – Well 1

Ground water quality samples were analyzed for general mineral, general physical, inorganics, boron, volatile organic compounds, semi-volatile organic compounds, and gross alpha and beta radionuclides. There were no sample results exceeding the maximum contaminant levels (MCL) established by the California Department of Health Services (DHS) for drinking water. However, the iron concentration in the sample from Well 1 was 0.3 milligrams per liter (mg/l) which is equivalent to the secondary drinking water standards MCL for iron. Contaminants listed by the DHS under secondary standards are regulated to maintain the aesthetic qualities of the water. Their presence in tap water does not pose a health hazard. The laboratory reports are included in Appendix C.



Well 2 (Old Well)

Well 2 was drilled and constructed in October 1975 by Arroyo Water Well Supply. According to the driller's log, the well was completed to a depth of 80 feet, with 20 feet of screen. The log did not indicate the specific screened interval or the depth of the sanitary seal. The drilling log is included in Appendix A.

Prior to the beginning of the pump test the static water level was measured at 24.83 feet below the top of the well casing. At the end of the test, the pumping water level was 26.35 feet below the top of the well casing. Water levels dropped a total of 1.52 feet during the test. A 56-minute recovery test was conducted at the well following the pump test, beginning when the pump was shut off. During this time water levels recovered to 25.07 feet below the top of the casing, or within 0.24 feet of the static water level. The pump test data and graphs are included in Appendix B.

Water Quality – Well 2

Ground water quality samples were analyzed for volatile organic compounds, semi-volatile organic compounds, and gross alpha and beta radionuclides. A water quality sample was obtained at Well 2 by others in July 2005, and analyzed by Creek Laboratories for general minerals, general physical, and inorganics. There were no sample results exceeding the MCLs established by the DHS for drinking water. The laboratory reports are included in Appendix C.

Conclusions

The pump test results indicate that there is minimal drawdown in Wells 1 and 2, and there is insignificant pumping interference from one well to the other. Water quality results indicate that the ground water produced by the two wells is suitable for domestic use.

Based on the pump test results, we recommend installing a pump capable of producing 200 gpm in each well, with a pump setting of 75 feet depth in Well 1. We recommend that a down-hole video camera be used to determine the screened interval in Well 2 and that a pump be installed three to five feet above the top of the screened interval. If you have any questions regarding this letter, please contact our office.

Sincerely,

David R. Williams
Associate Geologist

Attachments

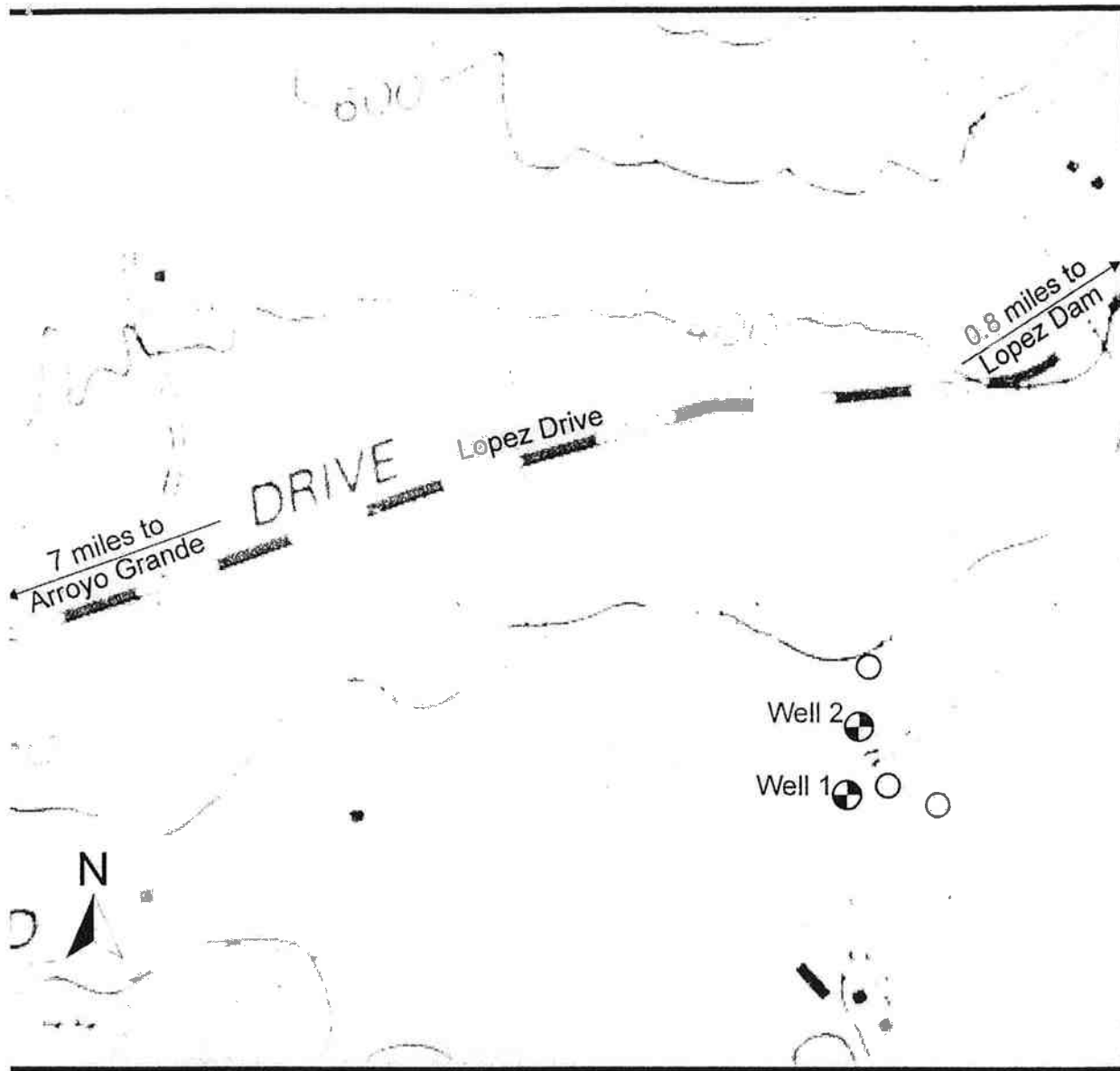

Source: U.S. Geological Survey 7.5 Minute Series topographic map, Arroyo Grande NE Quadrangle (1965).

Scale: 1 inch = 500 feet
 Contour interval = 40 feet

Explanation

- ☉ Project Well
- Existing Pennington Ranch Well

Figure 1
 Location Map
 Biddle Ranch Phase II
 Pennington Ranch

Cleath & Associates

DATE
 r's Copy
 1 of 1

STATE OF CALIFORNIA
WELL COMPLETION REPORT
 Refer to Instruction Pamphlet

No. **1084102**

Well No. #1
 Work Began 10-14-05, Ended 10-14-05
 Permit Agency SLO
 Permit No. 2005-354 Permit Date 10-12-05

STATE WELL NO./STATION NO.	
LATITUDE	LONGITUDE
APN/TRS/OTHER	

GEOLOGIC LOG

DEPTH FROM SURFACE	DEPTH	DESCRIPTION
0 to FL		Describe material, grain size, color, etc.
	20	sticky dark clay
	22	light brown clay & gravel
	45	big gravel
	53	brown clay
	138	big gravel
	140	blue clay

WELL OWNER
 Name Biddle Ranch Company/Dor, Tall
 Mailing Address 3000 Branch Mill Rd.
 City Arroyo Grande CA. 93420 STATE Z

WELL LOCATION
 Address Pennington Ranch/4050 Lopez
 City Arroyo Grande
 County San Luis Obispo
 APN Book 047 Page 021 Parcel 012
 Township 31S Range 14E Section 32
 Lat 35 10 35 N Long 120 13 25 W
 DEG. MIN. SEC. DEG. MIN. SEC.

LOCATION SKETCH
 NORTH

WEST EAST

SEE ATTACHED MAP

SOUTH

Illustrate or Describe Distance of Well from Roads, Buildings, Fences, Rivers, etc. and attach a map. Use additional paper if necessary. PLEASE BE ACCURATE & COMPLETE.

- ACTIVITY ()
 NEW WELL
 MODIFICATION/REP
 Deepen
 Other (Sp)
 DESTROY (Des Procedures and Under "GEOLO")
 USES ()
 WATER SUPPLY
 Domestic
 Irrigation
 MONITOR
 TEST W
 CATHODIC PROTECT
 HEAT EXCHAI
 DIRECT PI
 INJECT
 VAPOR EXTRACT
 SPARG
 REMEDIAT
 OTHER (SPEC

WATER LEVEL & YIELD OF COMPLETED WELL
 DEPTH TO FIRST WATER 30' (FL) BELOW SURFACE
 DEPTH OF STATIC WATER LEVEL 25' (FL) & DATE MEASURED 10-14-05
 ESTIMATED YIELD 500+ (GPM) & TEST TYPE air lift
 TEST LENGTH _____ (Hrs.) TOTAL DRAWDOWN _____ (FL)
 * May not be representative of a well's long-term yield.

AL DEPTH OF BORING 140' (Feet)
 AL DEPTH OF COMPLETED WELL 140' (Feet)

DEPTH FROM SURFACE	BORE-HOLE DIA. (Inches)	CASING (S)					MATERIAL / GRADE	INTERNAL DIAMETER (Inches)	GAUGE OR WALL THICKNESS	SLOT SIZE IF ANY (Inches)	DEPTH FROM SURFACE	ANNULAR MATERIAL TYPE			
		TYPE ()										CE-MENT ()	BEN-TONITE ()	FILL ()	FILTER (TYPE)
0 to FL		BLANK	SCREEN	CON-DUCTOR	FILL PIPE						FL to FL				
0 to 80	15"	X				F480/PVC	8"	SDR21			0 to 50'	X			
0 to 140	15"		X			F480/PVC	8"	SDR21	.040		50 to 140'				

- ATTACHMENTS ()
- Geologic Log
 - Well Construction Diagram
 - Geophysical Log(s)
 - Soil/Water Chemical Analyses
 - Other

CERTIFICATION STATEMENT
 I, the undersigned, certify that this report is complete and accurate to the best of my knowledge and belief.
 NAME Central Coast Drilling, INC.
 (PERSON, FIRM, OR CORPORATION) (TYPED OR PRINTED)
225 Main St. Templeton CA. 93465
 ADDRESS CITY STATE ZIP
 Signed [Signature] 10-12-05

WELL PERMIT PLOT PLAN

AN LUIS OBISPO COUNTY HEALTH DEPARTMENT
156 Sierra Way
an Luis Obispo, California 93401
alephone: 805-781-5544

SCALE: 1/4" = 25'

INDICATE BELOW THE EXACT LOCATION OF WELL WITH RESPECT TO THE FOLLOWING ITEMS: PROPERTY LINES, WATER BODIES OR WATER COURSES, DRAINAGE PATTERN, ROADS, EXISTING WELLS, SEWERS AND PRIVATE SEWAGE DISPOSAL SYSTEMS. INCLUDE DIMENSIONS.

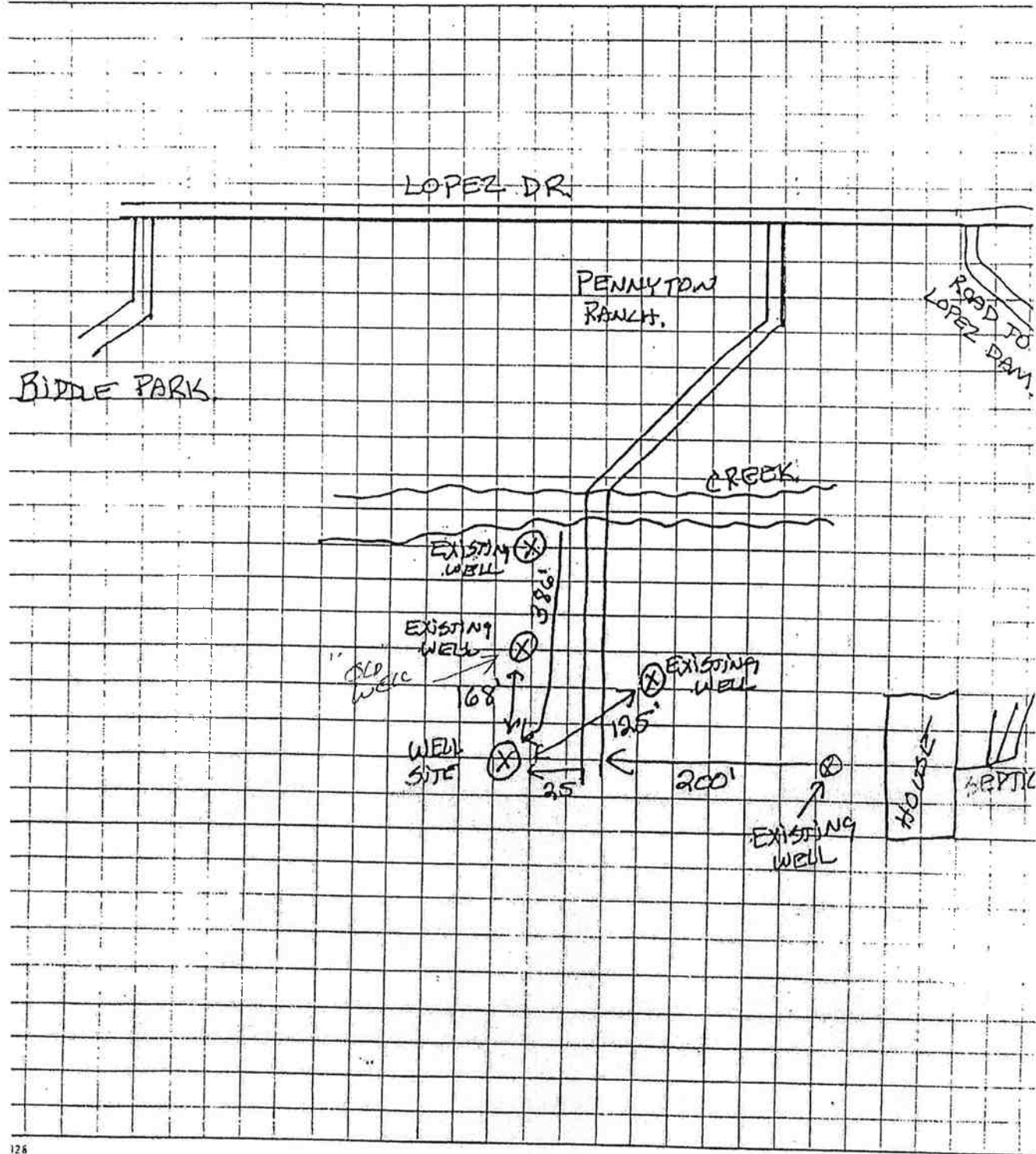

DRILLING LOG

Arroyo Water Well Supply

P. O. Box 157
 Arroyo Grande, Calif.
 489-2258

Date 10-9-75

Owner LORIN A. PENNINGTON

Location 4055 LOPEZ DR

City ARROYO GRANDE State CA

Total Depth 80'

Static Water Level 22'

Casing Size 10"

Screen Size _____ Length 20'

Kind of Wire _____ Gauge _____

Estimated Capacity _____ gals./min.

Kind of Pump _____

Depth of Pump Setting _____ Ft.

H.P. _____ Voltage _____ Phase _____

Size of Tank _____

0	TOP SOIL
9	CLAY
25	GRAVEL AND CLAY
34	CLAY AND GRAVEL
40	SAND AND LOOSE GRAVEL
80	GRAVEL AND LOOSE SAND

Log of Well		Drill Pipe	Depth	Casing
				Shoe
		Bit		1
		1		2
		2		3
		3		4
50	350	4		5
		5		6
		6		7
		7		8
		8		9
100	400	9		10
		10		11
		11		12
		12		13
		13		14
150	450	14		15
		15		16
		16		17
		17		18
		18		19
		19		20
200	500	20		21
		21		22
		22		23
		23		24
		24		25
250	550	25		26
		26		27
		27		28
		28		29
		29		30
300	600	30		31

ping Test (72 hour), Pennington Well #1, (New Well) March 20 to 23, 2006

Day	Time	Elapsed Time	Depth to Water	Drawdown	Recorded Pumping Rate
/Day/Yr	hr:min	minutes	feet	feet	gallons per minute
0/2006	14:40	0	25.98	0	200
	14:41	1	27.24	1.26	200
	14:42	2	27.25	1.27	200
	14:43	3	27.27	1.29	200
	14:44	4	27.32	1.34	200
	14:45	5	27.28	1.30	200
	14:46	6	27.29	1.31	200
	14:48	8	27.29	1.31	200
	14:50	10	27.3	1.32	200
	14:52	12	27.31	1.33	200
	14:55	15	27.3	1.32	200
	15:00	20	27.31	1.33	200
	15:05	25	27.29	1.31	200
	15:10	30	27.31	1.33	200
	15:20	40	27.31	1.33	200
	15:30	50	27.3	1.32	200
	15:40	60	27.3	1.32	200
	15:55	75	27.31	1.33	200
	16:10	90	27.3	1.32	200
	16:25	105	27.3	1.32	200
	16:40	120	27.31	1.33	200
	17:10	150	27.29	1.31	200
	17:40	180	27.3	1.32	200
	18:40	240	27.3	1.32	200
	21:40	420	27.31	1.33	200
21/2006	0:40	800	27.33	1.35	200
	3:40	780	27.34	1.36	200
	6:40	960	27.36	1.38	200
	7:40	1020	27.36	1.38	200
	8:40	1080	27.36	1.38	200
	11:40	1260	27.36	1.38	200
	14:40	1440	27.34	1.36	200
	17:40	1620	27.34	1.36	200
	23:40	1980	27.34	1.36	200
22/2006	6:40	2400	27.34	1.36	200
	9:40	2580	27.34	1.36	200
	13:40	2820	27.34	1.36	200
	16:40	3000	27.345	1.37	200
	19:40	3180	27.345	1.37	200
	22:40	3360	27.345	1.37	200
23/2006	6:40	3840	27.35	1.37	200
	9:40	4020	27.35	1.37	200
	12:40	4200	27.35	1.37	200
	14:55	4335			

STOP

Recovery Test, Pennington Well #1 (New Well) March 23, 2006

Day	Time	Elapsed Time	Depth to Water	Elapsed Time	Recovery Time Ratio
/Day/Yr	hr:min	minutes	feet	minutes	t/t(0)
3/2006	14:55	4335.25	26.40	0.25	17341
	14:55	4335.50	26.38	0.5	8671
	14:55	4335.75	26.27	0.75	5781
	14:56	4336.08	26.27	1.08	4015
	14:56	4336.42	26.28	1.42	3054
	14:56	4336.75	26.25	1.75	2478
	14:57	4337.00	26.24	2.00	2169
	14:57	4337.25	26.23	2.25	1928
	14:57	4337.50	26.23	2.50	1735
	14:57	4337.75	26.23	2.75	1577
	14:58	4338.00	26.24	3.00	1446
	14:58	4338.50	26.24	3.50	1240
	14:59	4339.00	26.22	4.00	1085
	15:00	4340.00	26.22	5.00	868
	15:01	4341.00	26.22	6.00	724
	15:02	4342.00	26.21	7.00	620
	15:04	4344.00	26.20	9.00	483
	15:05	4345.00	26.20	10.00	435
	15:07	4347.00	26.20	12.00	362
	15:35	4375.00	26.16	40.00	109
	15:40	4380.00	26.16	45.00	97
	15:50	4390.00	26.16	55.00	80

Pumping Test (72 hour) - Pennington Well #1 (New Well)

March 20 to 23, 2006

Depth to Static Water Level: 25.98 feet

Ave Pumping Rate: 200 gpm

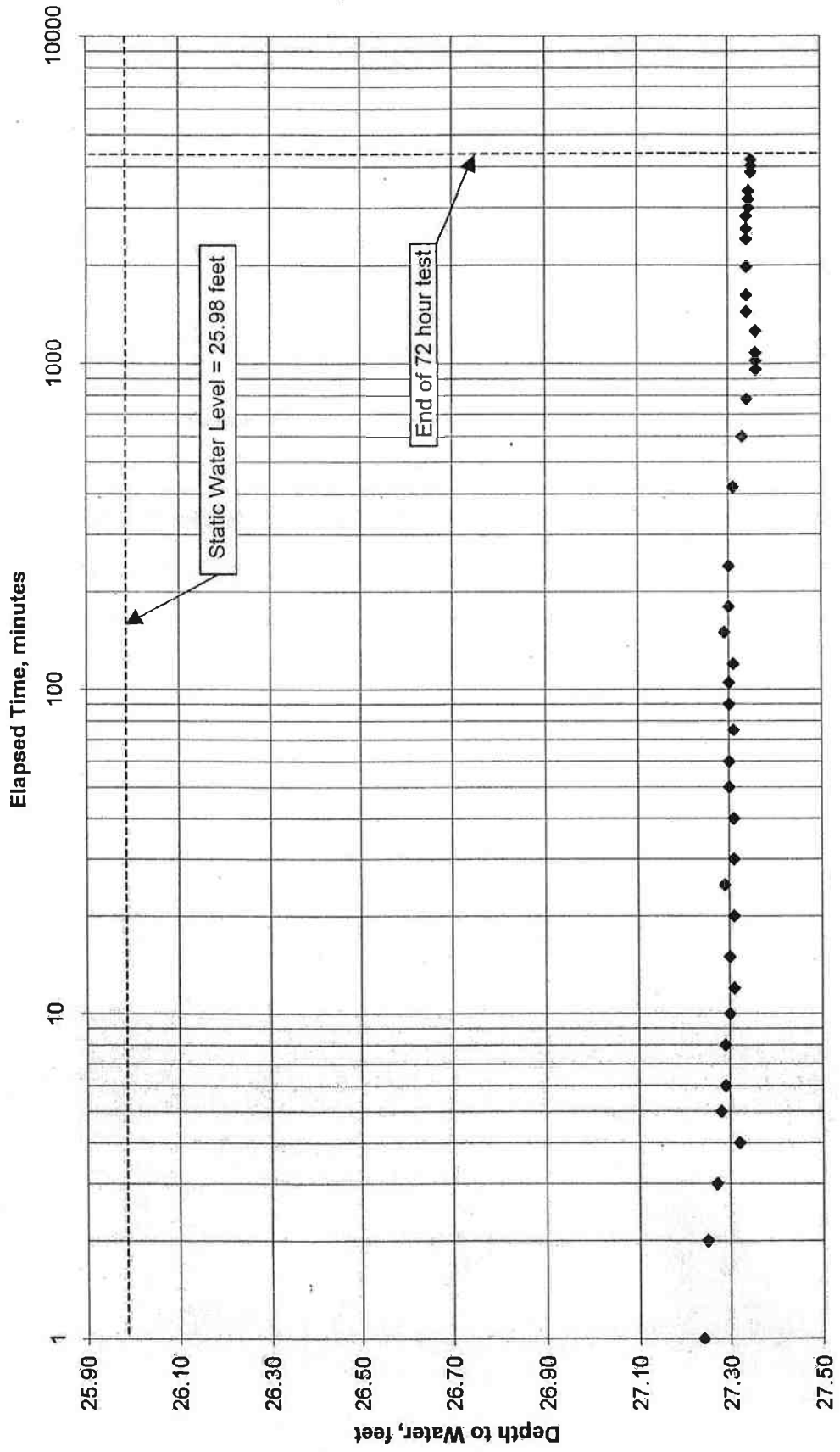

Recovery Test - Pennington Well #1 (New Well)

March 23, 2006

Depth to Static Water Level: 25.98 feet

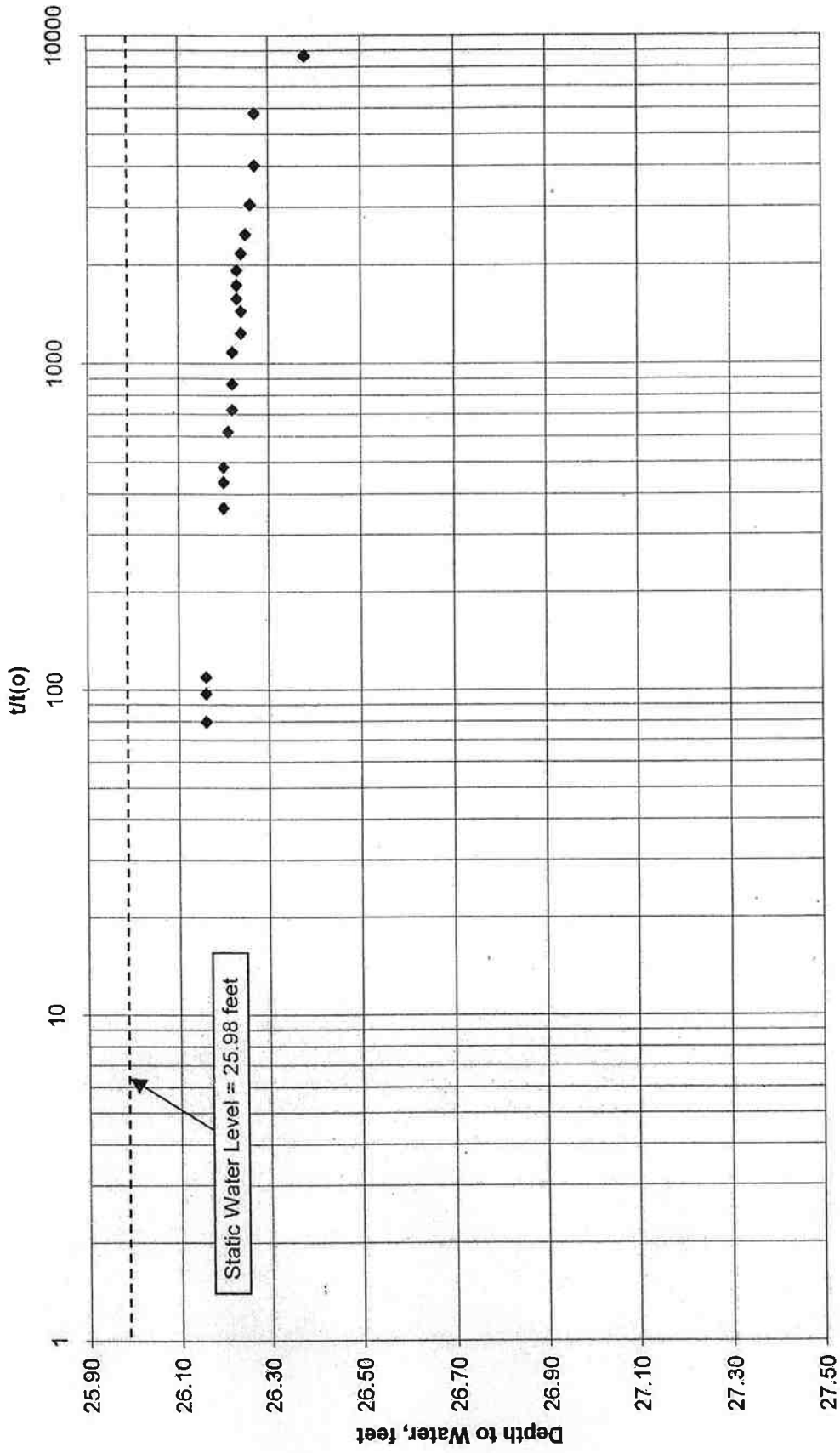

umping Test (72 hour), Pennington Well #2 (Old Well), March 20 to 23, 2006

Day	Time	Elapsed Time	Depth to Water	Drawdown	Recorded Pumping Rate
/Day/Yr	hr:min	minutes	feet	feet	gallons per minute
30/2006	14:30	0	24.83	0	190
	14:31	1	26.08	1.25	190
	14:32	2	26.08	1.25	190
	14:33	3	26.08	1.25	190
	14:34	4	26.08	1.25	190
	14:35	5	26.08	1.25	190
	14:36	6	26.08	1.25	190
	14:38	8	26.08	1.25	190
	14:40	10	26.13	1.30	190
	14:42	12	26.16	1.33	190
	14:45	15	26.17	1.34	190
	14:50	20	26.19	1.36	190
	14:55	25	26.20	1.37	190
	15:00	30	26.21	1.38	190
	15:10	40	26.21	1.38	190
	15:20	50	26.22	1.39	190
	15:30	60	26.22	1.39	190
	15:45	75	26.23	1.40	190
	16:00	90	26.23	1.40	190
	16:15	105	26.23	1.40	190
	16:30	120	26.24	1.41	190
	17:00	150	26.26	1.43	190
	17:30	180	26.26	1.43	190
	18:30	240	26.27	1.44	190
	21:30	420	26.28	1.45	190
21/2006	0:30	600	26.29	1.46	190
	3:30	780	26.30	1.47	190
	6:30	960	26.33	1.50	190
	7:30	1020	26.33	1.50	190
	8:30	1080	26.34	1.51	190
	11:30	1260	26.33	1.50	190
	14:30	1440	26.33	1.50	190
	17:30	1620	26.34	1.51	190
	23:30	1980	26.34	1.51	190
22/2006	6:30	2400	26.34	1.51	190
	9:30	2580	26.34	1.51	190
	13:30	2820	26.34	1.51	190
	16:30	3000	26.35	1.52	190
	19:30	3180	26.35	1.52	190
	22:30	3360	26.35	1.52	190
23/2006	6:30	3840	26.35	1.52	190
	9:30	4020	26.35	1.52	190
	12:30	4200	26.35	1.52	190
	14:34	4324			190

STOP

Recovery Test, Pennington Well 2 (Old Well), March 23, 2006

Day	Time	Elapsed Time	Depth to Water	Elapsed Time	Recovery Time Ratio
/Day/Yr	hr:min	minutes	feet	minutes	t/t(0)
Recovery		t	s	t(0)	t/t(0)
3/2006	14:34	4324.45	25.29	0.45	9610
	14:34	4324.83	25.25	0.83	5211
	14:35	4325.00	25.28	1.00	4325
	14:35	4325.33	25.29	1.33	3252
	14:35	4325.67	25.28	1.67	2590
	14:36	4326.00	25.22	2.00	2163
	14:36	4326.50	25.23	2.50	1731
	14:37	4327.00	25.22	3.00	1442
	14:38	4328.00	25.21	4.00	1082
	14:39	4329.00	25.21	5.00	866
	14:40	4330.00	25.21	6.00	722
	14:41	4331.00	25.21	7.00	619
	14:42	4332.00	25.21	8.00	542
	14:43	4333.00	25.21	9.00	481
	14:44	4334.00	25.21	10.00	433
	15:10	4360.00	25.09	36.00	121
	15:20	4370.00	25.08	46.00	95
	15:25	4375.00	25.08	51.00	86
	15:30	4380.00	25.07	56.00	78

Recovery Test - Pennington Well #2 (Old Well)

March 23, 2006

Depth to Static Water Level: 24.83 feet

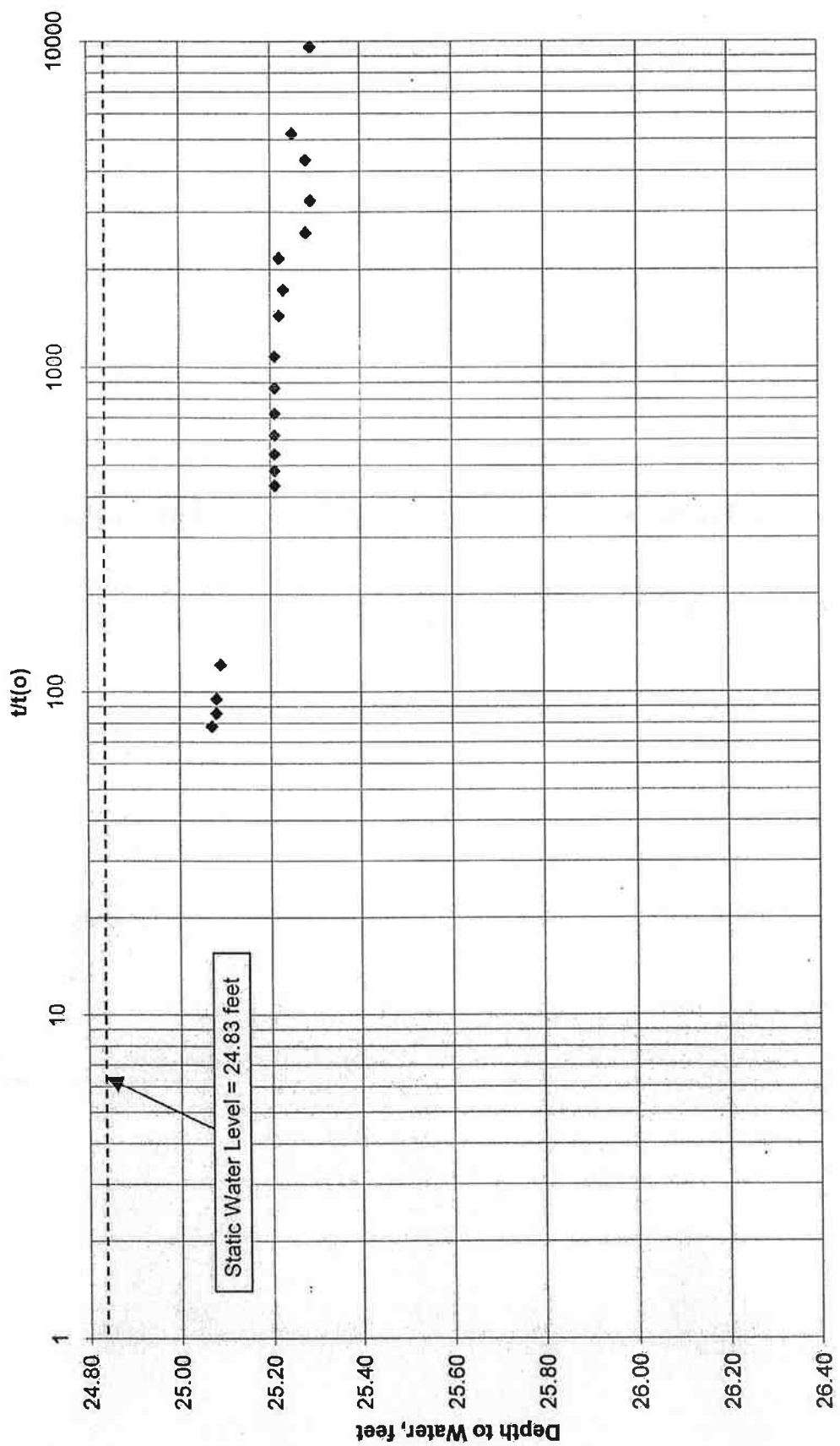



CREEK ENVIRONMENTAL LABORATORIES, INC.

A Minority-owned Business Enterprise

141 SUBURBAN ROAD, SUITE C-5 • SAN LUIS OBISPO, CA 93401 • (805) 545-9838 • FAX (805) 545-0107

Ryan Talley
 Talley Farms
 P.O. Box 360
 Arroyo Grande, CA 93420

Log Number: 06-C3344
 Order: N1588
 Received: 03/20/06

REPORT OF ANALYTICAL RESULTS

SAMPLE DESCRIPTION	SAMPLED BY	SAMPLED		MATRIX	ANALYZED
		DATE & TIME			
Well #1 new well (Well A)		03/20/06	15:15	Drinking Water	
ANALYTE	RESULT	DLR	UNITS	METHOD	ANALYZED
Total Alkalinity as CaCO ₃	250	2	mg/L	SM 2320B	03/24/06
Chloride	21	1	mg/L	EPA 300.0	03/21/06
Total Cyanide	Not Detected	0.005	mg/L	EPA 335.2	03/22/06
Color	Not Detected	1	units	SM 2120B	03/20/06
Electrical Conductance	820	1	umhos/cm	SM 2510	03/20/06
Fluoride	0.3	0.1	mg/L	EPA 300.0	03/21/06
Langlier Index (Corrosivity)	0.2	---	pH units	SM 2330B	03/20/06
MBAS (Anionic Surfactants MW=340)	Not Detected	0.05	mg/L	SM 5540 C	03/22/06
Nitrate as N	0.4	0.1	mg/L	EPA 300.0	03/21/06
Nitrate as NO ₃	1.8	0.4	mg/L	EPA 300.0	
Nitrite as N	Not Detected	0.1	mg/L	EPA 300.0	03/21/06
Odor	Not Detected	1	TCN	SM 2150B	03/20/06
pH	7.3	0.0	units	EPA 150.1	03/20/06
Sulfate	170	0.5	mg/L	EPA 300.0	03/21/06
Total Dissolved Solids	540	10	mg/L	EPA 160.1	03/22/06
Turbidity	0.7	0.1	NTU	EPA 100.1	03/20/06
Calcium	92	0.03	mg/L	EPA 200.7	03/28/06
Hardness	410	1	mg/L CaCO ₃	EPA 200.7	
Iron	0.3	0.1	mg/L	EPA 200.7	03/28/06
Mercury	Not Detected	0.001	mg/L	EPA 245.1	03/24/06
Potassium	2.3	0.1	mg/L	EPA 200.7	03/28/06
Magnesium	43	0.03	mg/L	EPA 200.7	03/28/06
Sodium	35	0.05	mg/L	EPA 200.7	03/28/06
Benzene	Not Detected	0.5	ug/L	EPA 524.2	03/22/06
Bromobenzene	Not Detected	0.5	ug/L	EPA 524.2	03/22/06
Bromochloromethane	Not Detected	0.5	ug/L	EPA 524.2	03/22/06
Bromodichloromethane	Not Detected	0.5	ug/L	EPA 524.2	03/22/06
Bromoform	Not Detected	0.5	ug/L	EPA 524.2	03/22/06
Bromomethane	Not Detected	0.5	ug/L	EPA 524.2	03/22/06
t-Butyl Alcohol (TBA)	Not Detected	2	ug/L	EPA 524.2	03/22/06
n-Butylbenzene	Not Detected	0.5	ug/L	EPA 524.2	03/22/06



CREEK ENVIRONMENTAL LABORATORIES, INC.

A Minority-owned Business Enterprise

141 SUBURBAN ROAD, SUITE C-5 • SAN LLUIS OBISPO, CA 93401 • (805) 545-9838 • FAX (805) 545-0107

Ryan Talley
Talley Farms
P.O. Box 360
Arroyo Grande, CA 93420

Log Number: 06-C3344
Order: N1588
Received: 03/20/06

REPORT OF ANALYTICAL RESULTS

SAMPLE DESCRIPTION	SAMPLED BY	SAMPLED		MATRIX	
		DATE & TIME			
Well #1 new well		03/20/06@16:15		Drinking Water	
ANALYTE	RESULT	DLR	UNITS	METHOD	ANALYZED
Beryllium	Not Detected	0.001	mg/L	EPA 200.8	03/29/06
Boron	0.06	0.05	mg/L	EPA 200.8	03/29/06
Cadmium	0.001	0.001	mg/L	EPA 200.8	03/29/06
Chromium	Not Detected	0.01	mg/L	EPA 200.8	03/29/06
Copper	Not Detected	0.05	mg/L	EPA 200.8	03/29/06
Lead	Not Detected	0.005	mg/L	EPA 200.8	03/29/06
Manganese	0.042	0.02	mg/L	EPA 200.8	03/29/06
Nickel	Not Detected	0.01	mg/L	EPA 200.8	03/29/06
Selenium	Not Detected	0.005	mg/L	EPA 200.8	03/29/06
Silver	Not Detected	0.01	mg/L	EPA 200.8	03/29/06
Thallium	Not Detected	0.001	mg/L	EPA 200.8	03/29/06
Zinc	Not Detected	0.05	mg/L	EPA 200.8	03/29/06

DLR = Detection Limit for Reporting. Results of "Not Detected" are below DLR.

CREEK ENVIRONMENTAL LABORATORIES

Lab Director, Michael Ng



CREEK ENVIRONMENTAL LABORATORIES, INC.

A Minority-owned Business Enterprise

141 SUBURBAN ROAD, SUITE C-5 • SAN LUIS OBISPO, CA 93401 • (805) 545-9838 • FAX (805) 545-0107

Ryan Talley
Talley Farms
P.O. Box 360
Arroyo Grande, CA 93420

Log Number: 06-C3344
Order: N1588
Received: 03/20/06

REPORT OF ANALYTICAL RESULTS

SAMPLE DESCRIPTION	SAMPLED BY	SAMPLED		MATRIX	
		DATE	TIME		
Well #1 new well		03/20/06	06:15	Drinking Water	
ANALYTE	RESULT	DLR	UNITS	METHOD	ANALYZED
n-Butylbenzene	Not Detected	0.5	ug/L	EPA 524.2	03/22/06
sec-Butyl Benzene	Not Detected	0.5	ug/L	EPA 524.2	03/22/06
Carbon Tetrachloride	Not Detected	0.5	ug/L	EPA 524.2	03/22/06
Chlorobenzene	Not Detected	0.5	ug/L	EPA 524.2	03/22/06
Chloroethane	Not Detected	0.5	ug/L	EPA 524.2	03/22/06
Chloroform	Not Detected	0.5	ug/L	EPA 524.2	03/22/06
Chloromethane	Not Detected	0.5	ug/L	EPA 524.2	03/22/06
2-Chlorotoluene	Not Detected	0.5	ug/L	EPA 524.2	03/22/06
4-Chlorotoluene	Not Detected	0.5	ug/L	EPA 524.2	03/22/06
Dibromochloromethane	Not Detected	0.5	ug/L	EPA 524.2	03/22/06
Dibromomethane	Not Detected	0.5	ug/L	EPA 524.2	03/22/06
1,2-Dibromoethane (EDB)	Not Detected	0.5	ug/L	EPA 524.2	03/22/06
Dichlorodifluoromethane (R12)	Not Detected	0.5	ug/L	EPA 524.2	03/22/06
1,2-Dichlorobenzene	Not Detected	0.5	ug/L	EPA 524.2	03/22/06
1,3-Dichlorobenzene	Not Detected	0.5	ug/L	EPA 524.2	03/22/06
1,4-Dichlorobenzene	Not Detected	0.5	ug/L	EPA 524.2	03/22/06
1,1-Dichloroethane	Not Detected	0.5	ug/L	EPA 524.2	03/22/06
1,2-Dichloroethane (EDC)	Not Detected	0.5	ug/L	EPA 524.2	03/22/06
1,1-Dichloroethene	Not Detected	0.5	ug/L	EPA 524.2	03/22/06
cis-1,2-Dichloroethene	Not Detected	0.5	ug/L	EPA 524.2	03/22/06
trans-1,2-Dichloroethene	Not Detected	0.5	ug/L	EPA 524.2	03/22/06
1,2-Dichloropropane	Not Detected	0.5	ug/L	EPA 524.2	03/22/06
1,3-Dichloropropane	Not Detected	0.5	ug/L	EPA 524.2	03/22/06
2,2-Dichloropropane	Not Detected	0.5	ug/L	EPA 524.2	03/22/06
1,1-Dichloropropene	Not Detected	0.5	ug/L	EPA 524.2	03/22/06
cis-1,3-Dichloropropene	Not Detected	0.5	ug/L	EPA 524.2	03/22/06
trans-1,3-Dichloropropene	Not Detected	0.5	ug/L	EPA 524.2	03/22/06
Ethyl t-Butyl Ether (ETBE)	Not Detected	0.5	ug/L	EPA 524.2	03/22/06
Ethylbenzene	Not Detected	0.5	ug/L	EPA 524.2	03/22/06
Hexachlorobutadiene	Not Detected	0.5	ug/L	EPA 524.2	03/22/06
Isopropylbenzene	Not Detected	0.5	ug/L	EPA 524.2	03/22/06



CREEK ENVIRONMENTAL LABORATORIES, INC.

A Minority-owned Business Enterprise

141 SUBURBAN ROAD, SUITE C-3 • SAN LUIS OBISPO, CA 93401 • (805) 545-9838 • FAX (805) 545-0107

Ryan Talley
 Talley Farms
 P.O. Box 360
 Arroyo Grande, CA 93420

Log Number: 06-C3344
 Order: N1500
 Received: 03/20/06

REPORT OF ANALYTICAL RESULTS

SAMPLE DESCRIPTION	SAMPLED BY	SAMPLED DATE & TIME	MATRIX		
Well #1 new Well		03/20/06@16:15	Drinking Water		
ANALYTE	RESULT	DLR	UNITS	METHOD	ANALYZED
Diisopropyl Ether (DIPE)	Not Detected	0.5	ug/L	EPA 524.2	03/22/06
p-Isopropyltoluene	Not Detected	0.5	ug/L	EPA 524.2	03/22/06
Methylene Chloride	1.0	0.5	ug/L	EPA 524.2	03/22/06
Methyl t-Butyl Ether (MTBE)	Not Detected	0.5	ug/L	EPA 524.2	03/22/06
Naphthalene	Not Detected	0.5	ug/L	EPA 524.2	03/22/06
n-Propylbenzene	Not Detected	0.5	ug/L	EPA 524.2	03/22/06
Styrene	Not Detected	0.5	ug/L	EPA 524.2	03/22/06
t-Amyl Methyl Ether (TAME)	Not Detected	0.5	ug/L	EPA 524.2	03/22/06
1,1,1,2-Tetrachloroethane	Not Detected	0.5	ug/L	EPA 524.2	03/22/06
1,1,2,2-Tetrachloroethane	Not Detected	0.5	ug/L	EPA 524.2	03/22/06
Tetrachloroethene (PCE)	Not Detected	0.5	ug/L	EPA 524.2	03/22/06
Toluene	Not Detected	0.5	ug/L	EPA 524.2	03/22/06
1,2,3-Trichlorobenzene	Not Detected	0.5	ug/L	EPA 524.2	03/22/06
1,2,4-Trichlorobenzene	Not Detected	0.5	ug/L	EPA 524.2	03/22/06
1,1,1-Trichloroethane	Not Detected	0.5	ug/L	EPA 524.2	03/22/06
1,1,2-Trichloroethane	Not Detected	0.5	ug/L	EPA 524.2	03/22/06
Trichloroethane	Not Detected	0.5	ug/L	EPA 524.2	03/22/06
Trichlorofluoromethane (F11)	Not Detected	0.5	ug/L	EPA 524.2	03/22/06
1,2,3-Trichloropropane	Not Detected	0.5	ug/L	EPA 524.2	03/22/06
1,2,4-Trimethylbenzene	Not Detected	0.5	ug/L	EPA 524.2	03/22/06
1,3,5-Trimethylbenzene	Not Detected	0.5	ug/L	EPA 524.2	03/22/06
Trichlorotrifluoroethane (F113)	Not Detected	0.5	ug/L	EPA 524.2	03/22/06
Vinyl Chloride	Not Detected	0.5	ug/L	EPA 524.2	03/22/06
m,p-Xylene	Not Detected	0.5	ug/L	EPA 524.2	03/22/06
o-Xylene	Not Detected	0.5	ug/L	EPA 524.2	03/22/06
Total THM's	Not Detected	0.5	ug/L	EPA 524.2	
Total Xylenes	Not Detected	0.5	ug/L	EPA 524.2	
Aluminum	Not Detected	0.05	mg/L	EPA 200.8	03/29/06
Antimony	Not Detected	0.006	mg/L	EPA 200.8	03/29/06
Arsenic	Not Detected	0.002	mg/L	EPA 200.8	03/29/06
Barium	Not Detected	0.1	mg/L	EPA 200.8	03/29/06

BSK ANALYTICAL LABORATORIES

Orval Osborne
 Creek Environmental Laboratories
 141 Suburban Road Suite CS
 San Luis Obispo, CA 93401

Certificate of Analysis ELAP Certificate #1180

Report Issue Date: 04/06/2006

BSK Submission #: 2006031714

BSK Sample ID #: 702383

Project ID: N1588

Project Desc:

Submission Comments:

Sample Type: Liquid
 Sample Description: Well 1 New Well (3344)
 Sample Comments:

Date Sampled: 03/20/2006
 Time Sampled: 1615
 Date Received: 03/22/2006

Organics

Analyte	Method	Result	Units	PQL	Dilution	DLR	Prep Date	Analysis Date
Dibromochloropropane	EPA 504.1	ND	µg/L	0.01	1	0.01	03/27/2006	04/04/2006
Bis(2-bromophenyl) ether	EPA 504.1	ND	µg/L	0.02	1	0.02	03/27/2006	04/04/2006
Aldrin	EPA 505	ND	µg/L	0.075	1	0.075	03/26/2006	03/27/2006
Chlordane	EPA 505	ND	µg/L	0.1	1	0.1	03/26/2006	03/27/2006
Chlorobalonyl (Diazon) Deriv	EPA 505	ND	µg/L	5.0	1	5.0	03/26/2006	03/27/2006
Dieldrin	EPA 505	ND	µg/L	0.02	1	0.02	03/26/2006	03/27/2006
Endrin	EPA 505	ND	µg/L	0.1	1	0.1	03/26/2006	03/27/2006
Heptachlor	EPA 505	ND	µg/L	0.01	1	0.01	03/26/2006	03/27/2006
Heptachlor epoxide	EPA 505	ND	µg/L	0.01	1	0.01	03/26/2006	03/27/2006
Hexachlorobenzene	EPA 505	ND	µg/L	0.50	1	0.50	03/26/2006	03/27/2006
Hexachlorocyclopentadiene	EPA 505	ND	µg/L	1.0	1	1.0	03/26/2006	03/27/2006
Lindane	EPA 505	ND	µg/L	0.2	1	0.2	03/26/2006	03/27/2006
Methoxychlor	EPA 505	ND	µg/L	10	1	10	03/26/2006	03/27/2006
PCBs: Arochlor Screen	EPA 505	ND	µg/L	0.5	1	0.5	03/26/2006	03/27/2006
Triphenylene	EPA 505	ND	µg/L	1.0	1	1.0	03/26/2006	03/27/2006
Trifluoroin	EPA 505	ND	µg/L	1.0	1	1.0	03/26/2006	03/27/2006
2,4,5-T	EPA 515.3	ND	µg/L	1.0	1	1.0	03/27/2006	03/28/2006
2,4,3-TP (Silver)	EPA 515.3	ND	µg/L	1.0	1	1.0	03/27/2006	03/28/2006
2,4-D	EPA 515.3	ND	µg/L	10	1	10	03/27/2006	03/28/2006
Baculic acid (Baculic)	EPA 515.3	ND	µg/L	2.0	1	2.0	03/27/2006	03/28/2006
Dalapon	EPA 515.3	ND	µg/L	10	1	10	03/27/2006	03/28/2006
Dicamba (Dicamba)	EPA 515.3	ND	µg/L	1.5	1	1.5	03/27/2006	03/28/2006
Dinoseb (DNBP)	EPA 515.3	ND	µg/L	2.0	1	2.0	03/27/2006	03/28/2006
Pentachlorophenol (PCP)	EPA 515.3	ND	µg/L	0.2	1	0.2	03/27/2006	03/28/2006
Picloram	EPA 515.3	ND	µg/L	1.0	1	1.0	03/27/2006	03/28/2006
Alachlor (Alachlor)	EPA 525.2	ND	µg/L	1.0	1	1.0	03/25/2006	03/31/2006
Azinphos (Azinphos)	EPA 525.2	ND	µg/L	0.5	1	0.5	03/25/2006	03/31/2006
Benzo(a)pyrene	EPA 525.2	ND	µg/L	0.1	1	0.1	03/25/2006	03/31/2006
bis(2-ethylhexyl) adipate	EPA 525.2	ND	µg/L	3.0	1	3.0	03/25/2006	03/31/2006
bis(2-ethylhexyl) phthalate	EPA 525.2	ND	µg/L	3.0	1	3.0	03/25/2006	03/31/2006
Bromacil (Bromacil)	EPA 525.2	ND	µg/L	10	1	10	03/25/2006	03/31/2006

mg/L: Milligrams/Liter (ppm)
 mg/Kg: Milligrams/Kilogram (ppm)
 µg/L: Micrograms/Liter (ppb)
 µg/Kg: Micrograms/Kilogram (ppb)
 % Rec: Percent Recovered (surrogates)

PQL: Practical Quantitation Limit
 DLR: Detection Limit for Reporting
 : PQL x Dilution
 ND: None Detected at DLR

H: Analyzed outside of hold time
 P: Preliminary result
 S: Suspect result. See Case Narrative for comments.
 E: Analysis performed by External laboratory.
 See External Laboratory Report attachments.

Report Authentication Code:

(1) (2) (3) (4) (5) (6) (7) (8) (9) (10) (11) (12) (13) (14) (15) (16) (17) (18) (19) (20) (21) (22) (23) (24) (25) (26) (27) (28) (29) (30) (31) (32) (33) (34) (35) (36) (37) (38) (39) (40) (41) (42) (43) (44) (45) (46) (47) (48) (49) (50) (51) (52) (53) (54) (55) (56) (57) (58) (59) (60) (61) (62) (63) (64) (65) (66) (67) (68) (69) (70) (71) (72) (73) (74) (75) (76) (77) (78) (79) (80) (81) (82) (83) (84) (85) (86) (87) (88) (89) (90) (91) (92) (93) (94) (95) (96) (97) (98) (99) (100)

Page 4 of 5



CREEK ENVIRONMENTAL LABORATORIES, INC.

A Minority-owned Business Enterprise

141 SUBURBAN ROAD, SUITE C-5 • SAN LUIS OBISPO, CA 93401 • (805) 545-9836 • FAX (805) 545-0107

Page 1

Ron Flechs
Talley Farms
P.O. Box 360
Arroyo Grande, CA 93420

Log Number: 05-C8439
Order: M3891
Project: Pennington
Received: 07/28/05

REPORT OF ANALYTICAL RESULTS

SAMPLE DESCRIPTION	SAMPLED BY	SAMPLED		MATRIX	ANALYZED
		DATE	TIME		
Well #2 (Pennington) (Well B)	L. Crane	07/28/05	09:10	Drinking Water	
ANALYTE	RESULT	DLR	UNITS	METHOD	ANALYZED
Total Alkalinity as CaCO ₃	260	2	mg/L	SM 2320B	08/03/05
Chloride	20	1	mg/L	EPA 300.0	07/28/05
Total Cyanide	Not Detected	0.005	mg/L	EPA 335.2	08/05/05
Color	Not Detected	1	units	SM 2120B	07/28/05
Electrical Conductance	830	1	umhos/cm	SM 2510	07/28/05
Fluoride	0.4	0.1	mg/L	EPA 300.0	07/28/05
Langlier Index (Corrosivity)	0.5	---	pH units	SM 2330B	08/09/05
MBAS (Anionic Surfactants MW=340)	Not Detected	0.05	mg/L	SM 5540 C	07/29/05
Nitrate as N	3.6	0.1	mg/L	EPA 300.0	07/28/05
Nitrate as NO ₃	16	0.4	mg/L	EPA 300.0	07/28/05
Nitrite as N	Not Detected	0.1	mg/L	EPA 300.0	07/28/05
Odor	Not Detected	1	TON	SM 2150B	07/28/05
pH	7.6	0.1	units	EPA 150.1	07/28/05
Sulfate	130	0.5	mg/L	EPA 300.0	07/28/05
Total Dissolved Solids	510	10	mg/L	EPA 160.1	08/03/05
Turbidity	Not Detected	0.1	NTU	EPA 180.1	07/28/05
Total Coliform Bacteria	Absent	---		SM9223	07/28/05
Calcium	95	0.03	mg/L	EPA 200.7	08/07/05
Hardness	400 <i>24 grains</i>	1	mg/L CaCO ₃	EPA 200.7	08/07/05
Iron	Not Detected	0.1	mg/L	EPA 200.7	08/07/05
Mercury	Not Detected	0.001	mg/L	EPA 245.1	08/02/05
Potassium	2.4	0.1	mg/L	EPA 200.7	08/07/05
Magnesium	38	0.03	mg/L	EPA 200.7	08/07/05
Sodium	27	0.05	mg/L	EPA 200.7	08/07/05
Aluminum	Not Detected	0.05	mg/L	EPA 200.8	08/07/05
Antimony	Not Detected	0.006	mg/L	EPA 200.8	08/07/05
Arsenic	Not Detected	0.002	mg/L	EPA 200.8	08/07/05
Barium	Not Detected	0.1	mg/L	EPA 200.8	08/07/05
Beryllium	Not Detected	0.001	mg/L	EPA 200.8	08/07/05
Cadmium	0.001	0.001	mg/L	EPA 200.8	08/07/05



CREEK ENVIRONMENTAL LABORATORIES, INC.

A Minority-owned Business Enterprise

141 SUBURBAN ROAD, SUITE C-3 • SAN LUIS OBISPO, CA 93401 • (805) 545-9838 • FAX (805) 545-0107

Page 2

Ron Flechs
Talley Farms
P.O. Box 360
Arroyo Grande, CA 93420

Log Number: 05-C8439
Order: M3891
Project: Pennington
Received: 07/28/05

REPORT OF ANALYTICAL RESULTS

SAMPLE DESCRIPTION	SAMPLED BY	SAMPLED DATE @ TIME	MATRIX		
Well #2 (Pennington)	L. Crane	07/28/05@09:10	Drinking Water		
ANALYTE	RESULT	DLR	UNITS	METHOD	ANALYZED
Chromium	Not Detected	0.01	mg/L	EPA 200.8	08/07/05
Copper	Not Detected	0.05	mg/L	EPA 200.8	08/07/05
Lead	Not Detected	0.005	mg/L	EPA 200.8	08/07/05
Manganese	0.033	0.02	mg/L	EPA 200.8	08/07/05
Nickel	Not Detected	0.01	mg/L	EPA 200.8	08/07/05
Selenium	Not Detected	0.005	mg/L	EPA 200.8	08/07/05
Silver	Not Detected	0.01	mg/L	EPA 200.8	08/07/05
Thallium	Not Detected	0.001	mg/L	EPA 200.8	08/07/05
Zinc	Not Detected	0.05	mg/L	EPA 200.8	08/07/05

DLR = Detection Limit for Reporting. Results of "Not Detected" are below DLR.

CREEK ENVIRONMENTAL LABORATORIES

Lab Director, Michael Ng

Exhibit B: Water System Calculations



November 17, 2005

Marina Michel, Environmental Health Specialist
Department of Health Services
P.O. Box 1489
San Luis Obispo, CA 93406

Subject: Biddle East Water Storage Calculations (Tract 2408, Phase 2)

Dear Marina:

These storage calculations are to accompany the submittal dated September 30, 2005 for the Tract 2408 Phase 2 (Biddle Ranch East) subdivision project. The previous submittal showed storage and supply calculations based on San Luis Obispo County Standards. At your request, we are showing storage requirements based on an 800 gpd per lot use estimate for the development.

Fire flow requirement = 1000 gpm for 2 hours = 120,000 gallons

Residential flow = 800 gpd for 56 lots = 44,800 gallons

Emergency storage = 2 days residential flow = 89,600 gallons

Total = 254,400 gallons storage required.

Based on the calculations we submitted in September (SLO County Standards), we proposed 254,200 gallons total storage for the project, which is essentially the same storage requirement.

The proposed well pumping rate is 120 gpm per well. At this rate, one well will pump the required daily residential use volume in just over 6 hours pumping time. We believe the proposed pumping capacity and storage volume are sufficient for the development.

Sincerely,

Matthew J. Wheeler, P.E.
Branch Manager

M:\S014-Don Talley\S014-001 Biddle Ranch East\4.0 Proj Doc\4.14 Environ Process\4.14.03 County Health Dept\Storage Calcs 111705.doc

CIVIL ENGINEERING

CONSTRUCTION
MANAGEMENT

LANDSCAPE
ARCHITECTURE

MECHANICAL
ENGINEERING

PLANNING

PUBLIC WORKS
ADMINISTRATION

SURVEYING /
GIS SOLUTIONS

WATER RESOURCES

WALLACE SWANSON
INTERNATIONAL

WALLACE GROUP
A California Corporation

1330 ARNOLD DR
SUITE 249
MARTINEZ
CALIFORNIA 94553

T 925 228-5801
F 925 228-5804

www.wallacegroup.us

Project: Biddle Run - East

Pro. No:

Calculated By: SLS

Date: 4/15/05

Scale:

Checked By:

Date:

Sheet 1 of 4

Water Demand & Storage Calcs

From SLO County Standards: 11-351.1711

Given

56-Lots

Fire Flow = 1000 gpm
min 20 psi

1. Average Daily Demand

- To meet customer demands
- Water source must produce:
 - no industry or Agriculture

$$ADD = 400L + \cancel{X} \text{ Agriculture}$$

$$= 400(56)$$

$$= 22,400 \text{ gpd} \leftarrow$$

✓ 120 gpm for 3 hrs.
✓ 80 gpm for 4.6 hrs

2. Peak Hourly Demand (PHD)

- To meet customer & fire demand for 120 min
- PHD must be satisfied by well pump capacity + well capacity + storage

$$PHD = Ncf + F + X + H$$

$$= (56)(7)(0.9) + 1500$$

$$= 1852 \text{ gpm @ 120 min} = 222,240 \text{ gal}$$

$$\text{Well pumps} = 120 \text{ gpm @ 120 min} = 14,400 \text{ gal}$$

$$\text{Total Storage} \rightarrow 207,840 \text{ gal}$$

For f:

f	Services
1.0	40
f	56
0.75	80

$$\frac{1-0.75}{f-1} = \frac{40-80}{56-40}$$

$$\frac{0.25}{f-1} = \frac{-40}{16}$$

$$-0.1 = f-1$$

$$f = 0.9$$



CIVIL ENGINEERING

CONSTRUCTION MANAGEMENT

LANDSCAPE ARCHITECTURE

MECHANICAL ENGINEERING

PLANNING

PUBLIC WORKS ADMINISTRATION

SURVEYING / GIS SOLUTIONS

WATER RESOURCES

WALLACE SWANSON INTERNATIONAL

4115 BROAD ST
SUITE B-5
SAN LUIS OBISPO
CALIFORNIA 93401

T 805 544-4011
F 805 544-4294

1330 ARNOLD DR
SUITE 249
MARTINEZ
CALIFORNIA 94553

T 925 228-5801
F 925 228-5804

www.wallacegroup.us

Project: Biddle Ranch East

Proj No:

Calculated By: SLS

Date: 4/15/05

Scale:

Checked By:

Date:

Sheet 2 of 4

Water Demand & Storage Calcs

From SLO County Standards: 11-351.1711

3. Storage

$$\begin{aligned} \text{Total Acres Served} \\ &= 2.17 \text{ ac/lot} \times 57 \text{ lots} \\ &= 123.7 \text{ ac} \end{aligned}$$

$$\begin{aligned} \text{Total Storage Capacity} \\ &= 625 \text{ gal/ac} \times 123.7 \text{ ac} \\ &= 78,125 \text{ gallons} \end{aligned}$$

Avg Lot Size = 2.17 ac

Lot Size	Storage per acre
2	650
2.17	S
3	500

$$\frac{2.17 - 2}{3 - 2} = \frac{S - 650}{500 - 650}$$

$$0.17 = \frac{S - 650}{-150}$$

$$-25 = S - 650$$

$$S = 625 \text{ gal/ac}$$

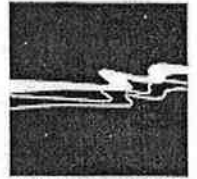

WALLACE GROUP

CIVIL ENGINEERING

CONSTRUCTION MANAGEMENT

LANDSCAPE ARCHITECTURE

MECHANICAL ENGINEERING

PLANNING

PUBLIC WORKS ADMINISTRATION

SURVEYING / GIS SOLUTIONS

WATER RESOURCES

WALLACE SWANSON INTERNATIONAL

4115 BROAD ST.
SUITE B-5
SAN LUIS OBISPO
CALIFORNIA 93401

T 805 544-4011
F 805 544-4294

1330 ARNOLD DR
SUITE 249
MARTINEZ
CALIFORNIA 94553

T 925 228-5801
F 925 228-5804

www.wallacegroup.us

Project: Biddle Ranch - East

Pro No:

Calculated By: SLS

Date: 4/15/05

Scale:

Checked By:

Date:

Sheet

3

of 4

Water Demand & Storage Calcs

From SLO County Stds - 11-351.1171

4. Required Residential Supply

a. With most critical well or pump inoperable

Storage + well capacity must provide the following for 2 hrs

$\frac{2}{3}(\text{Min Fire Flow} + \frac{1}{2} \text{ Peak hourly residential flow})$

$$\text{Fire flow} = 1500 \text{ gpm}$$

$$\frac{1}{2} \text{ PHD-resident} = \frac{1}{2} (352)$$

$$= 176 \text{ gpm}$$

$$\text{Total} = 1676 \text{ gpm}$$

$$1676 \text{ gpm}$$

$$\text{Two well pumps} = 120 \text{ gpm}$$

$$1476 @ 120 \text{ min} = 177,100 \text{ gal} \leftarrow \text{Storage}$$

$$\frac{2}{3} (1676) = 1117 \text{ gpm}$$

$$\text{One well pump} = 80 \text{ gpm}$$

$$1037 \text{ gpm} @ 120 \text{ min} = 124,400 \text{ gal} \leftarrow \text{Storage}$$



CIVIL ENGINEERING

CONSTRUCTION MANAGEMENT

LANDSCAPE ARCHITECTURE

MECHANICAL ENGINEERING

PLANNING

PUBLIC WORKS ADMINISTRATION

SURVEYING / GIS SOLUTIONS

WATER RESOURCES

WALLACE SWANSON INTERNATIONAL

4115 BROAD ST
SUITE B-5
SAN LUIS OBISPO
CALIFORNIA 93401

T 805 544-4011
F 805 544-4294

1330 ARNOLD DR
SUITE 249
MARTINEZ
CALIFORNIA 94553

T 925 228-5801
F 925 228-5804

www.wallacegroup.us

Project: Biddle Ranch - East

Proj No:

Calculated By: SLS

Date: 4/15/05

Scale:

Checked By:

Date:

Sheet 4 of 4

Water Demand & Storage Calc

4. Required Residential Supply

b. Storage & wells must provide the following - for 3 days

Min Residential Flow = MRF = $\frac{1}{2}$ Peak Hour Residential Flow

$$\text{MRF} = \frac{1}{2} (352 \text{ gpm})$$

$$= 176 \text{ gpm over } 4320 \text{ min.}$$

$$\text{well capacity} = 120 \text{ gpm}$$

$$\begin{aligned} \text{Required Storage} &= 56 \times 4320 \text{ min} \\ &= 241,920 \text{ gal} \leftarrow \end{aligned}$$

c. Pumping alone must satisfy Avg Daily Res. Flow (ADRF)

$$\begin{aligned} \text{ADRF} &= \frac{1}{3} (\text{PHRF}) = \frac{1}{3} (352) \\ &= 117 \text{ gpm} \end{aligned}$$

⇒ wells must be able to supply at least 117 gpm ←

d. using wells → N/A

Conclusion: 1. Use two wells, 120 gpm each

2. Total Storage = 250,000 gal - Bolted Steel

- Use two 126,000 gal (Nominal)

125,185 gal (actual)

- Each Tank - Diam = 29'-8 $\frac{3}{8}$ " (Inside)

Height = 24'-1.5"

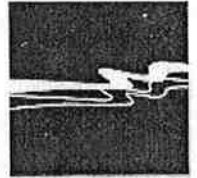

WALLACE GROUP

CIVIL ENGINEERING

CONSTRUCTION
MANAGEMENT

LANDSCAPE
ARCHITECTURE

MECHANICAL
ENGINEERING

PLANNING

PUBLIC WORKS
ADMINISTRATION

SURVEYING /
GIS SOLUTIONS

WATER RESOURCES

WALLACE SWANSON
INTERNATIONAL

4115 BROAD ST
SUITE B-5
SAN LUIS OBISPO
CALIFORNIA 93401

T 805 544-4011
F 805 544-4294

1330 ARNOLD DR
SUITE 249
MARTINEZ
CALIFORNIA 94553

F 925 228-5801
F 925 228-5804

www.wallacegroup.us



WALLACE GROUP

CIVIL ENGINEERING

CONSTRUCTION
MANAGEMENTLANDSCAPE
ARCHITECTUREMECHANICAL
ENGINEERING

PLANNING

PUBLIC WORKS
ADMINISTRATIONSURVEYING /
GIS SOLUTIONS

WATER RESOURCES

WALLACE SWANSON
INTERNATIONAL

Source Capacity & Storage Vol. Requirements

From: CA Code of Regulations,

Title 22 Chap. 16 Article 2 - §64563

P.18- §64564 - Source Capacity & Storage Volume Calc.s

(1) Max Daily Demand. Q_0 For 60 Connections: Chart 1 $\rightarrow Q_0 = 50 \text{ gpm}$
(For metered water systems)(2) Since total capacity @ source ($\sim 200 \text{ gpm}$) is greater
than Q_0 (50 gpm) - Total Storage Required from Table 3
 $V_0 = 60,000 \text{ gal}$

(3) N/A

Summary: Title 22 method yields $Q_0 = 50 \text{ gpm}$ & $V_0 = 60,000 \text{ gal}$

Actual Design for project calls for:

$$Q_{\max} = 352 \text{ gpm}$$

$$V_{\text{stor}} = 311,000 \text{ gal}$$

From SLO County
Standards 11-351.1711 \therefore Actual design is conservative & adequate4115 BROAD ST
SUITE B-5
SAN LUIS OBISPO
CALIFORNIA 93401T 805 544-4011
F 805 544-42941330 ARNOLD DR
SUITE 249
MARTINEZ
CALIFORNIA 94553T 925 228-5801
F 925 228-5804

www.wallacegroup.us

Exhibit C: Approved Construction Drawings

Static Pressure at Water Meter

Lot Number	Water Meter Elevation	Static Pressure at Meter (psi)
88	735	68
87	739	66
86	684	90
PRV 1	650	102
85	816	69
84	619	68
83	617	69
82	615	70
81	646	56
80	647	56
79	542	101
78	552	97
77	557	85
76	554	96
75	550	98
74	558	94
73	561	97
72	545	100
71	545	100
70	637	110
69	602	128
68	603	125
67	653	103
66	645	107
65	612	121
64	663	99
63	663	99
62	668	88
61	725	72
60	664	99
59	604	99
PRV 2	642	108
58	642	59
57	642	50
56	633	54
55	633	54
54	641	50
53	641	50
52	624	58
51	621	59
50	600	68
49	619	60
48	644	49
47	644	49
46	611	63
45	593	71
44	603	67
43	599	69
42	599	69
41	591	72
40	591	72
39	497	113
38	590	85
37	558	88
PRV 3	545	62
36	410	70
35	456	51
34	438	58

Location Number	Location	Station
1	TANK ROAD	5+00
2	CAMINO SAN GABRIEL	39+00
3	CAMINO SAN GABRIEL	3+00
4	CAMINO PURISIMA	98+00
5	CAMINO PURISIMA	66+50
6	CAMINO PURISIMA	34+00
7	WELL SITE	WELL A

From Elevation	To Elevation	Pipe Size	Pipe Schedule
Well Head	560	6"	CL 350 DIP
560	720 +/-	6"	C900 CL 200 PVC
720 +/-	Treatment Bldg	6"	C900 CL 150 PVC

Street Name	From Station	To Station	Pipe Size	Pipe Schedule
Camino Las Ventanas	0+00	9+00	6"	CL 350 DIP
Non Road Segment: Camino Las Ventanas to Lot 71				
	Elevation: Below 491.0		6"	CL 350 DIP
	Elevation: 491.0 to 676.0		6"	C900 CL 200 PVC
Camino San Gabriel	1+00	16+43	8"	C900 CL 200 PVC
	16+43	41+33	8"	C900 CL 150 PVC
Paseo Padua	1+00	7+17	6"	C900 CL 200 PVC
	7+17	11+88	8"	C900 CL 150 PVC
Camino Purisima	10+00	28+81.5	6"	CL 350 DIP
	28+81.5	56+18.5	8"	C900 CL 200 PVC
	56+18.5	88+74	10"	C900 CL 200 PVC
	88+74	142+13	10"	C900 CL 150 PVC
Tank Road	1+00	6+00	10"	C900 CL 150 PVC
Camino Obispo	8+76	18+31.5	8"	CL 350 DIP
Calle San Luis Rey	1+53	4+37	6"	CL 350 DIP
	4+37	10+46	6"	C900 CL 200 PVC
Avenida Alcola	1+56	15+62	10"	C900 CL 200 PVC
Calle Diego	1+53	4+19.5	10"	C900 CL 150 PVC
	4+19.5	11+19	10"	C900 CL 200 PVC
Via Buena Ventura	1+00	9+50	8"	C900 CL 200 PVC
Well Line	Elevation: Below 491.0		6"	C900 CL 150 PVC
	Elevation: 491.0 to 676.0		6"	C900 CL 200 PVC
	Elevation: 676.0 to 906.0		6"	CL 350 Ductile Iron

DUCTILE IRON PIPE (DIP) SPECIFICATION:
 * BURIED DIP SHALL BE WRAPPED WITH POLYETHYLENE IN ACCORDANCE WITH AWWA C105
 * ABOVE GROUND DIP SHALL BE COATED WITH AN EPOXY COATING IN ACCORDANCE WITH AWWA C116

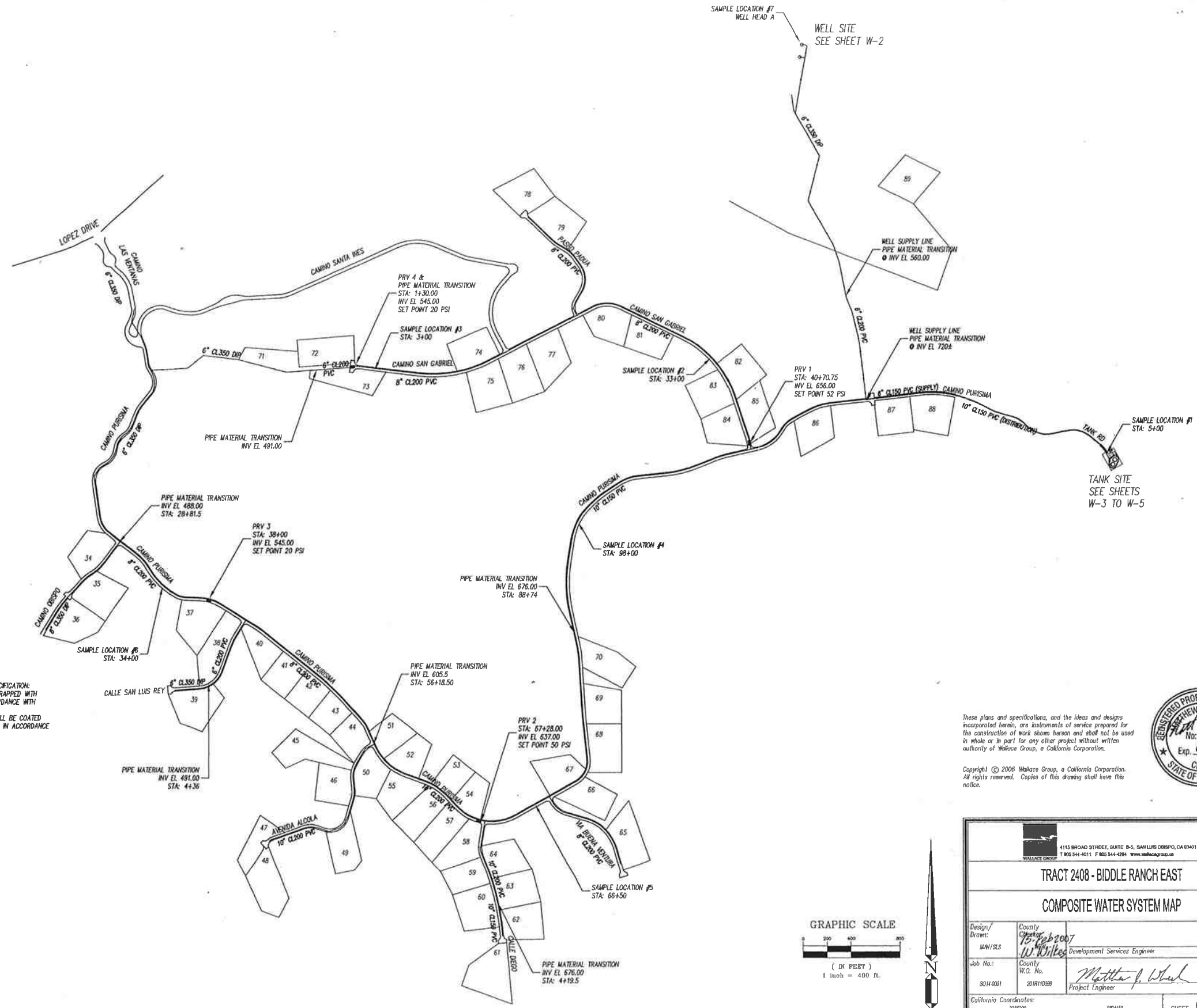

These plans and specifications, and the ideas and designs incorporated herein, are instruments of service prepared for the construction of work shown hereon and shall not be used in whole or in part for any other project without written authority of Wallace Group, a California Corporation.
 Copyright © 2006 Wallace Group, a California Corporation. All rights reserved. Copies of this drawing shall have this notice.

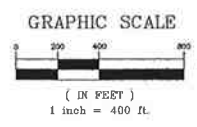

4115 BROAD STREET, SUITE B-5, SAN LUIS OBISPO, CA 93401 T 805 544-4011 F 805 544-4284 www.wallacegroup.us			
TRACT 2408 - BIDDLE RANCH EAST COMPOSITE WATER SYSTEM MAP			
Design/Drawn:	County:	City:	Date:
MW/SLS	San Luis Obispo	W. Wilkes	
Job No.:	County:	Project Engineer:	Date:
S014-0001	San Luis Obispo	Matthew J. Wilkes	01-23-07
California Coordinates:	N	E	SHEET W-1 OF 5
2256200		380450	

SAN LUIS OBISPO COUNTY DEPARTMENT OF PUBLIC WORKS

July 15, 2007

PROCEDURAL MEMORANDUM 0-3 (Revised)

TO: Division Head, Wastewater Division

FROM: Director of Public Works

SUBJECT: Wastewater Disinfection Procedures

The following memorandum outlines the revised procedure to be followed by laboratory personnel, water operators, inspectors and supervisors for the disinfection and testing of new wastewater extension and sewer mains. This procedure is an adaptation from the American Waterworks Association (AWWA) Standard for Disinfecting Water Mains (C651-99) and the new drinking water disinfection from the California Department of Health Services. Under this Memorandum should be included in specifications for all waterline projects.

The standard practice involves procedures for disinfecting new and installed water mains, including installation of free chlorine. All new water mains shall be disinfected before they are placed in service. All water mains shall be disinfected before they are returned to service. Adequately, also shall be taken to prevent contaminated materials from entering the water main during storage, construction or use.

Any activity associated with this procedure that may impact or affect the overall water system or impact on system operations, shall be reported to the Water Quality Manager prior to commencing work. All activities shall be carried through the Water Quality Manager.

BASIC DISINFECTION PROCEDURE

The basic disinfection procedure shall be:

- Inspect all materials to be used to insure the integrity of the materials.
- Provide contaminating materials from entering the water main during storage, construction, or repair and insure proper disinfection at the construction site.
- Flush, by flushing, the materials that may have entered the water main.

WATER SYSTEM DISINFECTION SYSTEM NOTES:

- DISINFECT WATER MAINS IN ACCORDANCE WITH PROCEDURES OUTLINED IN COUNTY OF SAN LUIS OBISPO PROCEDURAL MEMORANDUM 0-3 (INCLUDED ON THIS SHEET) & AWWA STANDARDS FOR DISINFECTING WATER MAINS (C651-99).
- POTABLE WATER SHALL BE USED FOR DISINFECTION OF THE MAINS.
- AN APPROVED DECHLORINATION PLAN SHALL BE REQUIRED OF CONTRACTOR PRIOR TO CHLORINATION & TANK FILLING.

WATER SYSTEM CONTROLS NOTES:

- RADIO CONTROLS SHALL BE USED TO COMMUNICATE BETWEEN TANK & WELL SITES. CONTRACTOR SHALL DEMONSTRATE FUNCTIONAL SYSTEM.
- LOW & HIGH WATER ALARMS SHALL TRIGGER FLASHING BEACONS AT THE TANK & WELL SITES IN ADDITION TO ALERTING THE OPERATOR THROUGH A TELEPHONE CONNECTION.
- WELL PUMPS SHALL BE AUTOMATICALLY CONTROLLED BY WATER ELEVATION IN THE TANKS - SEE SHEET W-4 FOR SET POINTS. IF PEAK ELECTRICITY RATES APPLY TO THE SITE, PUMPS SHALL BE AUTOMATED TO FILL TANKS EACH NIGHT STARTING AT 8PM.
- WELL A HAS EXISTING EQUIPMENT FOR REMOVAL. ALL SALVAGED EQUIPMENT SHALL BE DELIVERED TO THE OWNER.
- CONTROLLER SHALL ALTERNATE SOURCES AND CALL PUMPS SEQUENTIALLY TO MEET ON/OFF SET POINTS.
- CONTROLS FOR WELLS, FILTRATION AND CHLORINATION SYSTEMS SHALL BE INTEGRATED.
 - CHLORINATION SYSTEM SHALL DETECT FLOW IN PIPE AFTER FILTRATION SYSTEM TO TRIGGER SODIUM HYPOCHLORITE INJECTION.
 - WELL PUMPS SHALL BE TURNED OFF DURING FILTER BACKWASH CYCLE. WELL PUMPS SHALL RESUME OPERATIONS ONCE BACKWASH CYCLE IS COMPLETED.
 - BACKWASH SHALL BE AUTOMATED TO OCCUR WHEN HEADLOSS THROUGH FILTER IS BETWEEN 6-10 PSI.
 - CHLORINATION SYSTEM TO INJECT 12% SODIUM HYPOCHLORITE SOLUTION. APPROXIMATELY 1-2 GAL/DAY WILL BE CONSUMED.

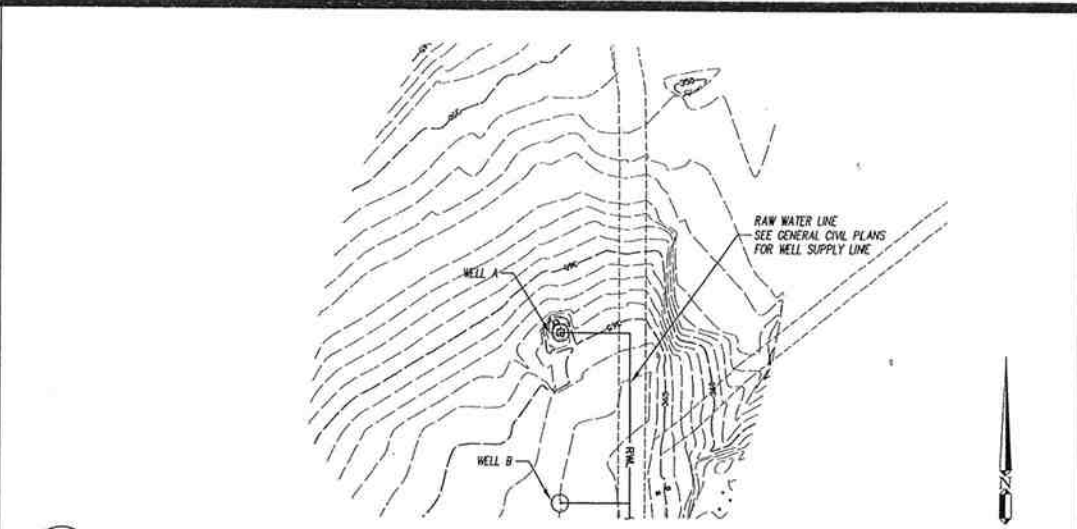

1 W-2 LOCATION OF WELLHEADS A & B SCALE 1" = 50'

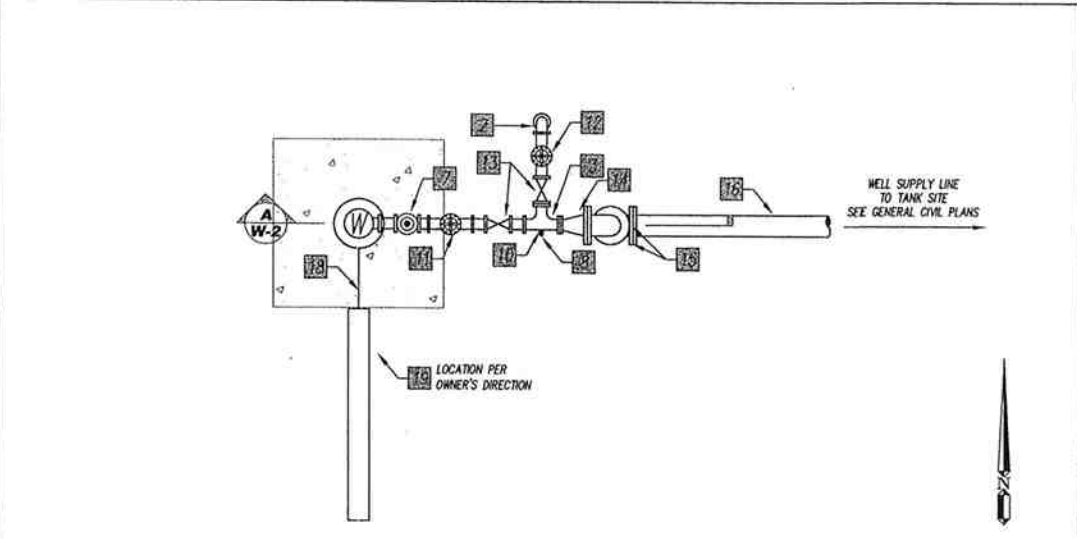

2 W-2 TYPICAL WELLHEAD - PLAN VIEW SCALE 1" = 2'

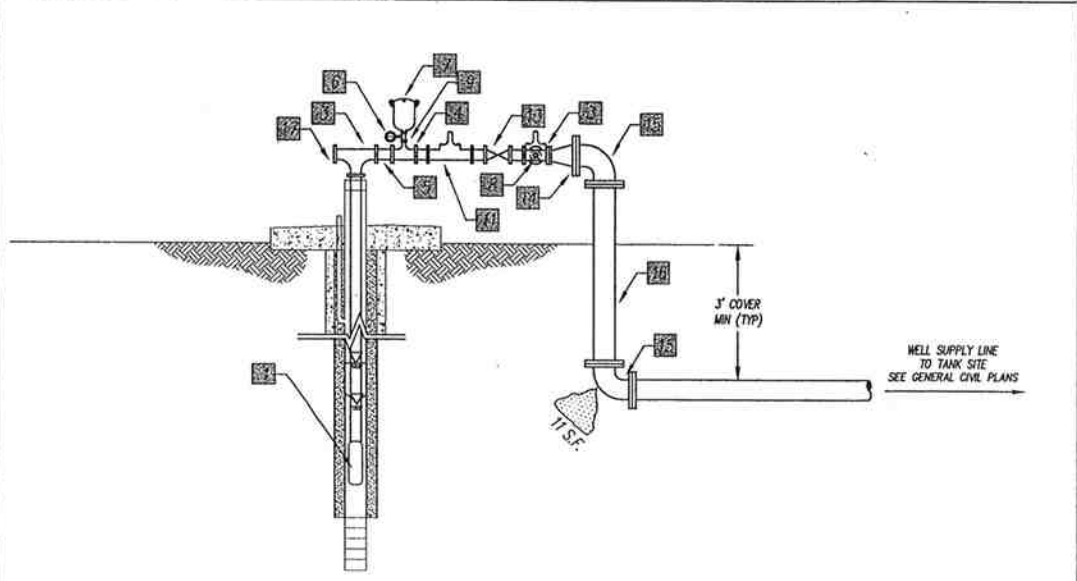

A W-2 TYPICAL WELLHEAD - SECTION VIEW SCALE 1" = 2'

SCHEDULE OF MATERIALS			
	WELL A	WELL B	
TOTAL DEPTH	TBD	TBD	
PUMPING WATER LEVEL	26 FT	TBD	
PUMP SETTING	TBD	TBD	
DESIGN PRODUCTION RATE	120 GPM	120 GPM	
TOTAL DYNAMIC HEAD	672 FT	672 FT	
1	1	1	GOULDS SUBMERSIBLE WELL PUMP 150S300-17 30HP 3450 RPM 3-PHASE, 480V
2	1	1	3" 90-DEG FITTING THREADED GALVANIZED STEEL
3	2	2	3/2" TEE FITTING THREADED GALVANIZED STEEL
4	1	1	3/2" TEE FITTING THREADED GALVANIZED STEEL
5	-	-	3" GALVANIZED STEEL (THREADED)
6	1	1	PRESSURE GAUGE OPERATING PRESSURE = 300PSI
7	1	1	1" CLA-VAL AIR/VACUUM RELEASE SERIES 371-WS-3
8	1	1	1/2" HOSE BIB ASSEMBLY
9	1	1	1" X 1/2" TEE GALVANIZED STEEL
10	1	1	1/2" GALVANIZED STEEL TAPPED
11	1	1	3" CLA-VAL GLOBE CHECK VALVE SERIES 81-02 CLASS 300, THREADED
12	1	1	3" CLA-VAL GLOBE PRES RELIEF VALVE SERIES 52-01 CLASS 300 LB, THREADED PRESSURE RANGE: 240-290 PSI
13	2	2	3" GATE VALVE, THREADED
14	1	1	6x3" REDUCER GALVANIZED STEEL
15	2	2	6" 90-DEG FITTING DI (FLANGED)
16	-	-	6" DI PIPE (FLANGED)
17	1	1	3" GALVANIZED STEEL BLIND FLANGE
18	-	-	CONDUIT (SEE THOMA PLANS)
19	1	-	CONTROL PANEL (SEE THOMA PLANS)

These plans and specifications, and the ideas and designs incorporated herein, are instruments of service prepared for the construction of work shown herein and shall not be used in whole or in part for any other project without written authority of Wallace Group, a California Corporation.

Copyright © 2006 Wallace Group, a California Corporation. All rights reserved. Copies of this drawing shall have this notice.

REGISTERED PROFESSIONAL ENGINEER
MATTHEW J. WHEELER
No. 61741
Exp. 6-28-07
CIVIL
STATE OF CALIFORNIA

4115 BRIDGEMAN STREET, SUITE B-5, SAN LUIS OBISPO, CA 95051
T 805 544-4211 F 805 544-4254 www.wallacegroup.com

TRACT 2408 - BIDDLE RANCH EAST

WELL SUPPLY

Design/Drawn:	County Checker:	Development Services Engineer	Date:
MW/SJS	15 Feb 2007	W. Willes	
Job No.:	County I.C. No.:	Project Engineer	Date:
S014-0001	201R10209	Matthew J. Wheeler	10-05-06

California Coordinates: N 225500 E 589450 SHEET W-2 OF 5

SCHEDULE OF MATERIALS								
ITEM NO.	DESCRIPTION	QUANTITY	ITEM NO.	DESCRIPTION	QUANTITY	ITEM NO.	DESCRIPTION	QUANTITY
1	EXTERNAL LIGHTS	-	9	10" 45° FITTING	1	22	4" 45° FITTING	2
2	WATER LEVEL INDICATOR	2	10	10" TEE	1	23	4" GATE VALVE	8
3	VENT	2	11	10" MUELLER OS&Y GATE VALVE FULLY RESTRAINED JOINTS	5	24	4" TEE	1
4	EXTERNAL LADDER W/ SAFETY CAGE	2	12	10" EBAA IRON FLEX-TEND DOUBLE BALL EXPANSION JOINT MODEL 410F21	2	25	4" SDR 35	-
5	ACCESS HATCH W/ INTERNAL LADDER	2	13	4" EBAA IRON FLEX-TEND DOUBLE BALL EXPANSION JOINT MODEL 40ME21	2	26	TRIPOD STORAGE TANK STAND W/ METERING PUMP MOUNTING SHELF	1
6	3" TAPPING SADDLE & GATE VALVE	1	14	12" HDPE	-	27	LIQUID CHLORINE METERING PUMP, STENNER SERIES 45	1
7	10" PVC CL150 C900	-	15	6" FLOOR DRAIN	7	28	CHLORINE LIQUID STORAGE, 35 GALLON P.E. TANK	1
8	10" 90° FITTING	6	16	6" PVC CL150 C900	-	29	1/2" BLACK PE TUBING WITH TAPPING SADDLE	-
			17	6" 90° FITTING	6	30	WARLO MCA-48 IRON/AIN FILTER	1
			18	6" X 4" REDUCER	-	31	SCADA ANTENNA	1
			19	4" WELDED GALVANIZED STEEL	-	32	3" SCH 40 PVC	-
			20	4" CL150 C900 PVC	-	33	4" # BOLLARD - CONCRETE FILLED	12
			21	4" 90° FITTING	20			

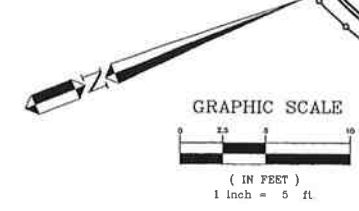
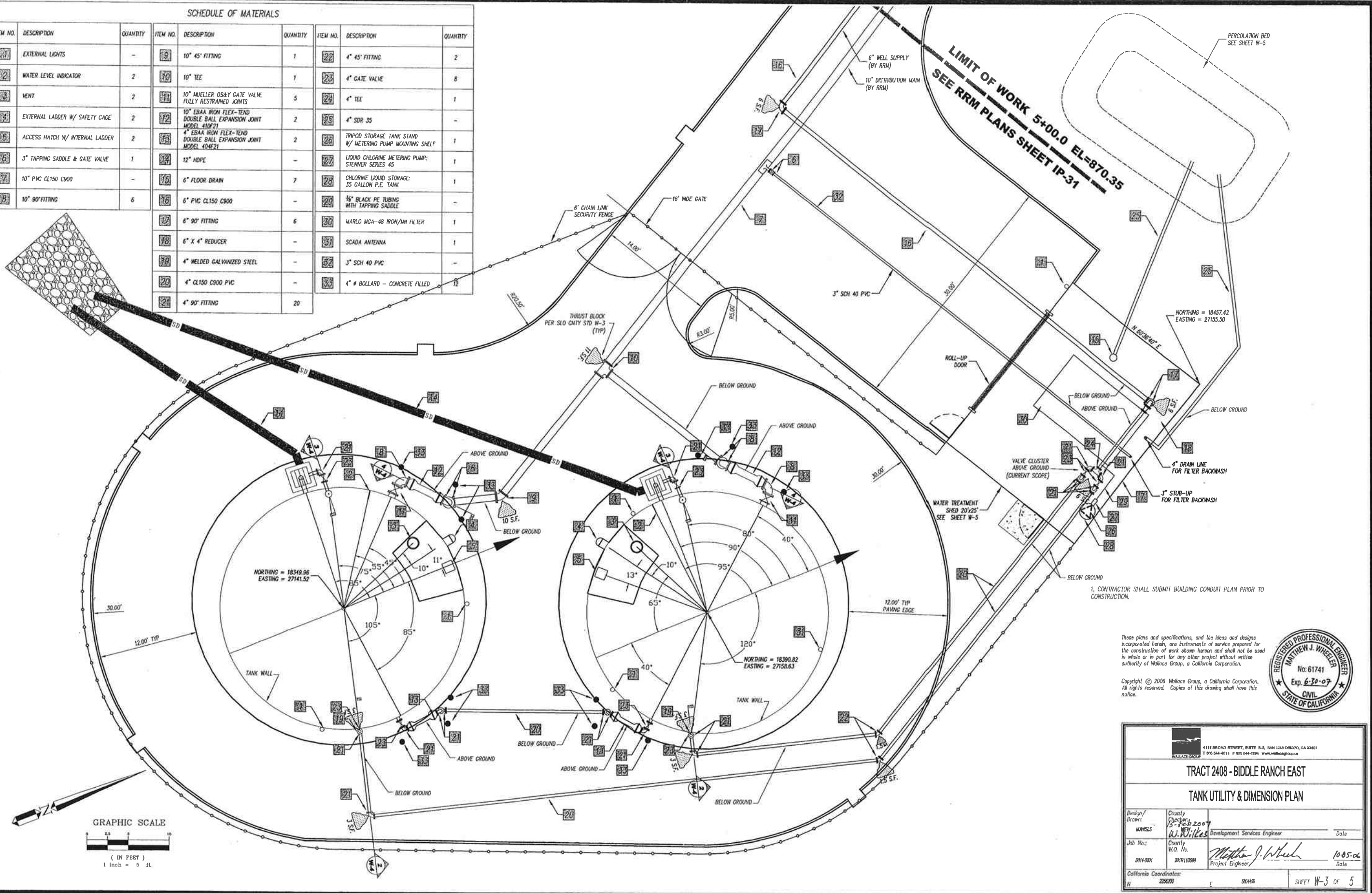
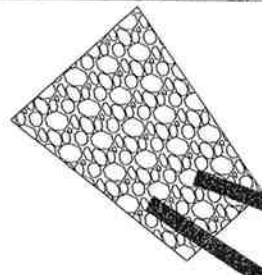

1. CONTRACTOR SHALL SUBMIT BUILDING CONDUIT PLAN PRIOR TO CONSTRUCTION.

These plans and specifications, and the ideas and designs incorporated herein, are instruments of service prepared for the construction of work shown hereon and shall not be used in whole or in part for any other project without written authority of Wallace Group, a California Corporation.

Copyright © 2006 Wallace Group, a California Corporation. All rights reserved. Copies of this drawing shall have this notice.



		4118 BRIDAL STREET, SUITE B-5, SAN LUIS OBISPO, CA 94601 T 805 544-4011 F 805 544-4294 www.wallacegroup.com	
TRACT 2408 - BIDDLE RANCH EAST			
TANK UTILITY & DIMENSION PLAN			
Design/Drawn: MAM/SLS	County Checker: W. Wilkes Development Services Engineer	Date:	Date:
Job No.: 8014-0001	County H.O. No.: 201R1/0899	Project Engineer: Matthew J. Wheeler	Date: 10.05.06
California Coordinates: N 2206200		E 800460	
		SHEET W-3 OF 5	

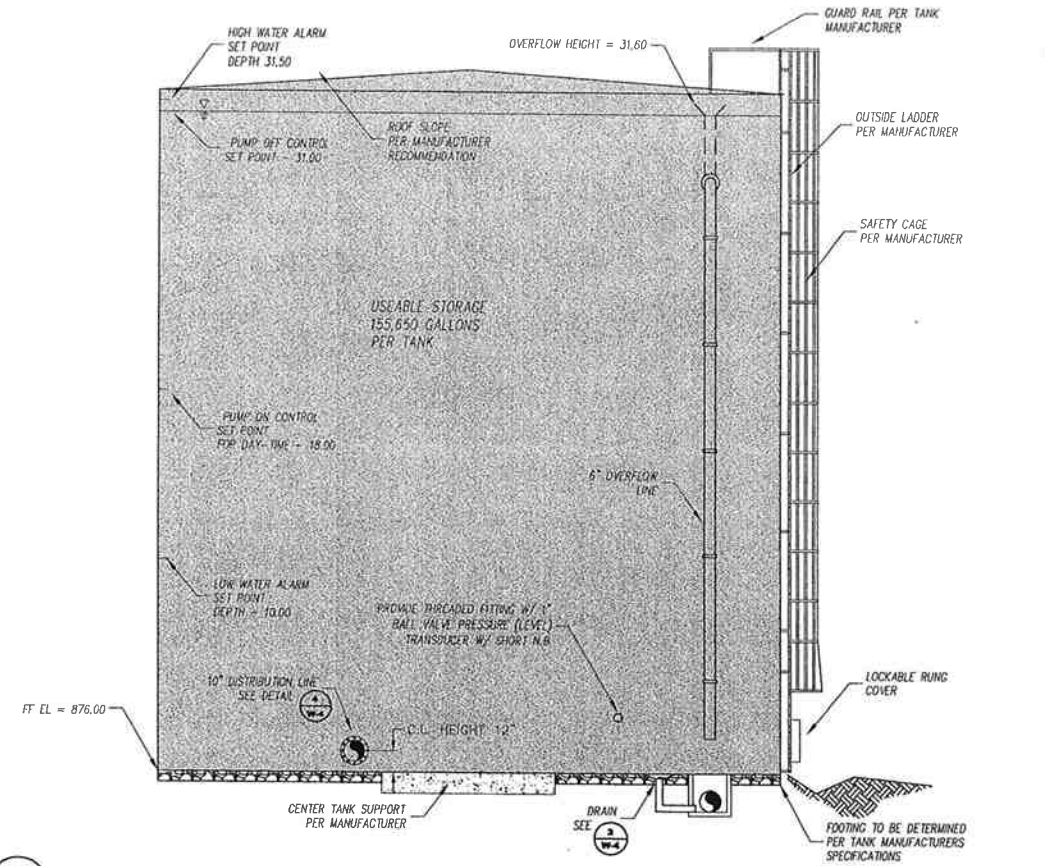

1 W-4 STORAGE TANK ELEVATION VIEW NTS

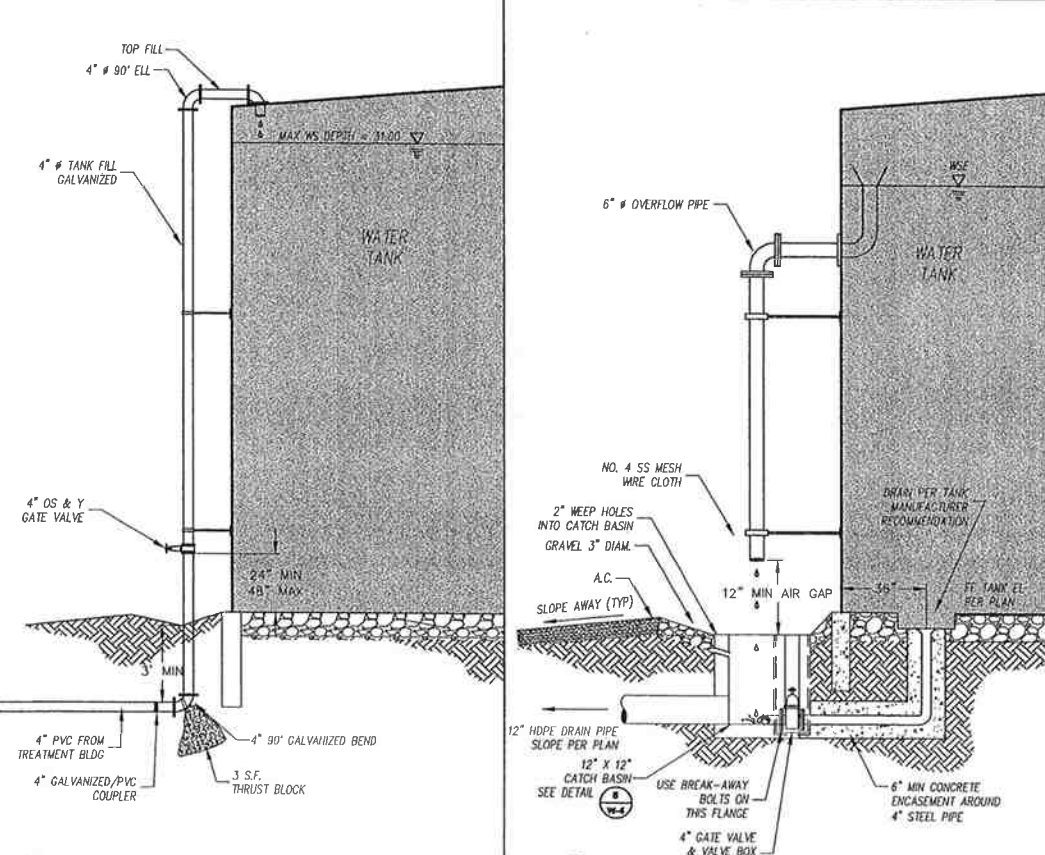

2 W-4 FILL LINE SECTION NTS

3 W-4 OVERFLOW / DRAIN SECTION NTS

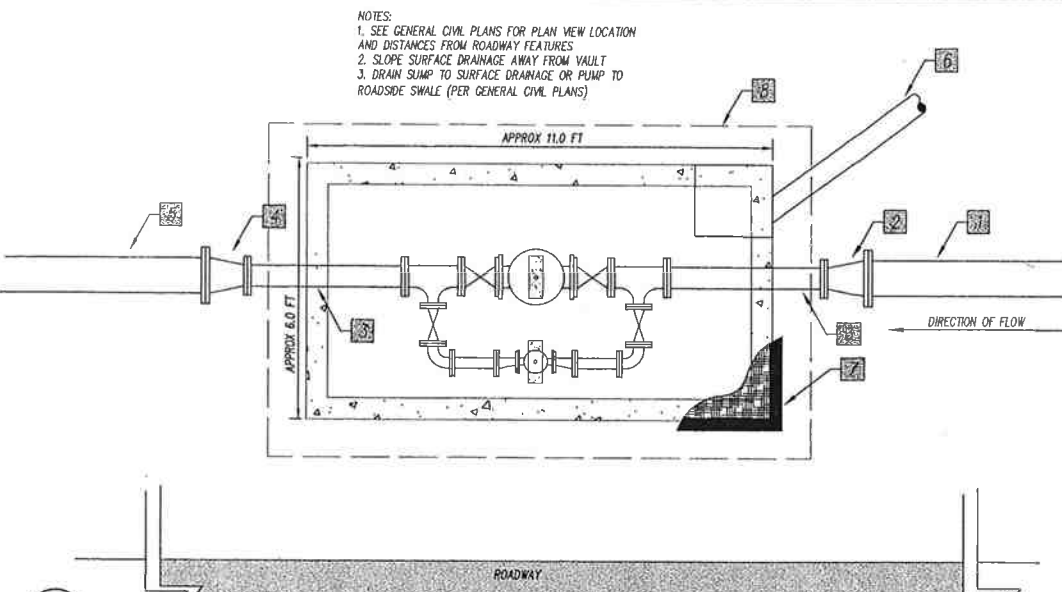

6 W-4 PRESSURE REDUCING STATION PLAN 1" = 2'

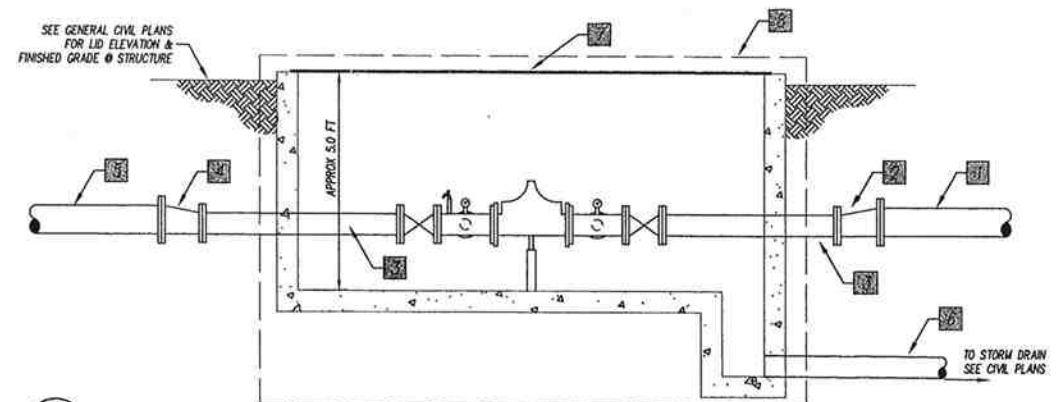

A W-4 PRESSURE REDUCING STATION SECTION NTS

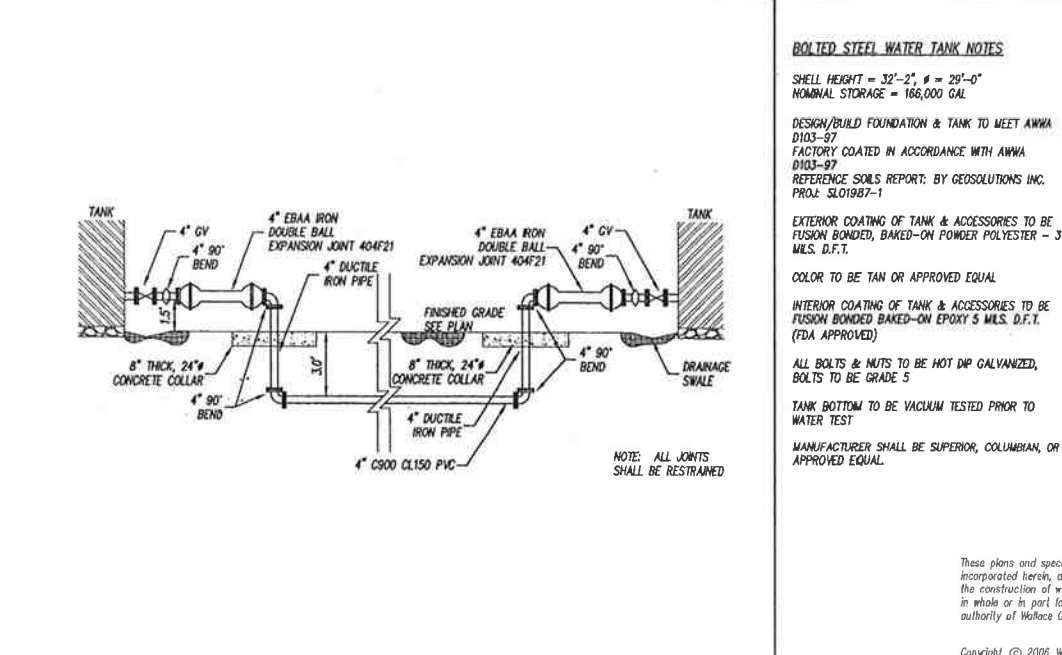

7 W-4 TANK EQUALIZATION PIPE NTS

SCHEDULE OF MATERIALS

	PRV 1	PRV 2	PRV 3	PRV 4
INLET SUPPLY PIPE	8" CL200 PVC	10" CL150 PVC	8" CL200 PVC	8" CL200 PVC
INLET SIDE REDUCER	8" X 6"	10" X 6"	8" X 6"	8" X 6"
PRV INLET / OUTLET PIPE	6" CL200 PVC	6" CL200 PVC	6" CL200 PVC	6" CL200 PVC
OUTLET REDUCER	8" X 6"	10" X 6"	8" X 6"	6" X 4"
OUTLET MAIN PIPE	8" CL200 PVC	10" CL200 PVC	8" CL200 PVC	4" CL200 PVC
6" PVC SDR 35 DRAIN PIPE	YES	YES	YES	YES
LIGHT DUTY ACCESS HATCH, DOUBLE DOOR, SPRING ASSISTED, LOCKING LID	YES	YES	YES	YES
PRESSURE REDUCING STATION BY HYDEC OR APPROVED EQUAL 6" PRESSURE REDUCING VALVE CLAVAL 90-01 AB OR APPROVED EQUAL 2 1/2" PRESSURE REDUCING VALVE CLAVAL 90-01 AS OR APPROVED EQUAL	YES	YES	YES	YES
OUTLET PRESSURE TO BE SET	52 PSI	50 PSI	20 PSI	20 PSI
DRAINAGE	GRAVITY	GRAVITY	SUMP PUMP	GRAVITY

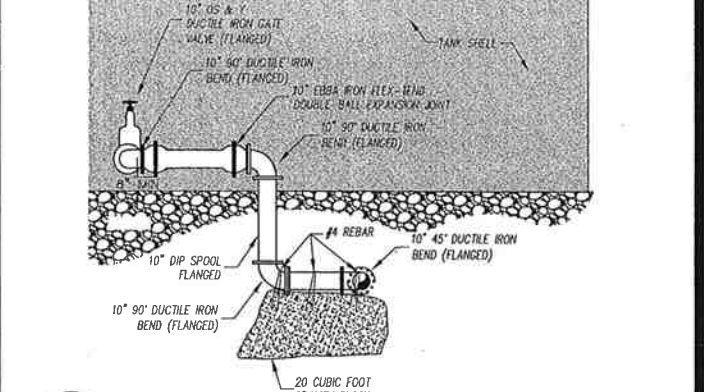

4 W-4 DISCHARGE PIPING DETAIL NTS

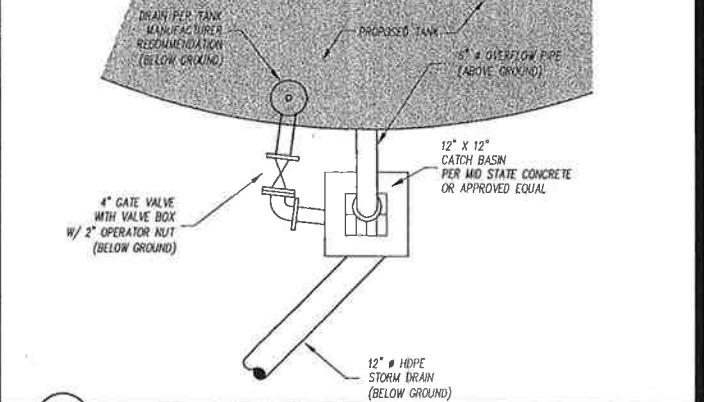

5 W-4 OVERFLOW / DRAIN PLAN NTS

BOLTED STEEL WATER TANK NOTES:

SHELL HEIGHT = 32'-2", # = 29'-0"
 NOMINAL STORAGE = 166,000 GAL

DESIGN/BUILD FOUNDATION & TANK TO MEET ANWA D103-97
 FACTORY COATED IN ACCORDANCE WITH ANWA D103-97
 REFERENCE SOILS REPORT: BY GEOSOLUTIONS INC. PROJ: SLO1987-1

EXTERIOR COATING OF TANK & ACCESSORIES TO BE FUSION BONDED, BAKED-ON POWDER POLYESTER - 3 MILS. D.F.T.

COLOR TO BE TAN OR APPROVED EQUAL

INTERIOR COATING OF TANK & ACCESSORIES TO BE FUSION BONDED BAKED-ON EPOXY 5 MILS. D.F.T. (FDA APPROVED)

ALL BOLTS & NUTS TO BE HOT DIP GALVANIZED, BOLTS TO BE GRADE 5

TANK BOTTOM TO BE VACUUM TESTED PRIOR TO WATER TEST

MANUFACTURER SHALL BE SUPERIOR, COLUMBIAN, OR APPROVED EQUAL



4115 BROAD STREET, SUITE 8-5, SAN LUIS OBISPO, CALIFORNIA 95060
 T 805.544.4511 F 805.544.4294 www.wallacegroup.com

TRACT 2408 - BIDDLE RANCH EAST

TANK & PRV DETAILS

Design/Drawn:	County:	Checked:	Date:
MMSLS	San Luis Obispo	W. Wilker	15-FEB-2007
Job No.:	County:	Project Engineer:	Date:
8014-001	San Luis Obispo	Matthew J. Wheeler	10-05-06

California Coordinates: N 256200 E 584400 SHEET W-4 OF 5

These plans and specifications, and the ideas and designs incorporated herein, are instruments of service prepared for the construction of work shown hereon, and shall not be used in whole or in part for any other project without written authority of Wallace Group, a California Corporation.

Copyright © 2006 Wallace Group, a California Corporation. All rights reserved. Copies of this drawing shall have this notice.

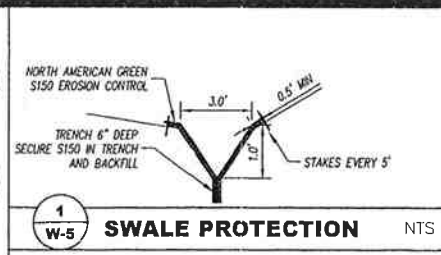
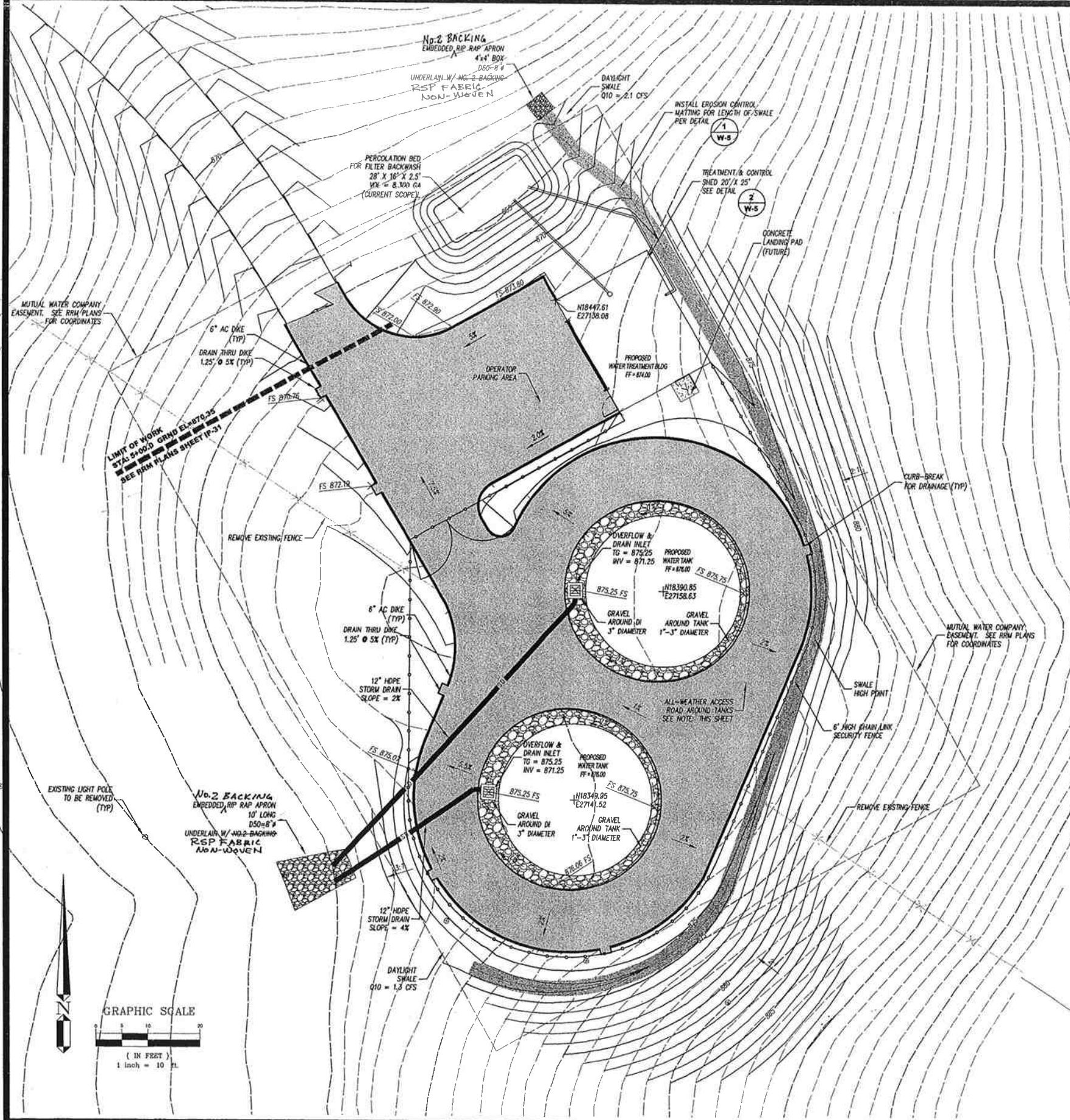

AC PAVEMENT SECTION NOTES:
 TRAFFIC INDEX = 5.0
 A.C. THICKNESS = 2.5"
 C.B. BASE THICKNESS = 4.0"
 C.B. BASE COMPACTED TO 95% R.C.
 TOP 12" SUBGRADE COMPACTED TO 95% R.C.

GRADING PLAN NOTES:
 1. FOR EROSION CONTROL/SEEDING SPECIFICATIONS, SEE RRM PLANS SHEET C-ED2
 2. PER SOIL REPORT FROM GEOSOLUTIONS, OVEREXCAVATION SHALL BE 12"-18" DUE TO THE EXISTENCE OF LOOSE SOIL AT THE TANK SITE. THIS VALUE MAY BE REDUCED WITH APPROVAL OF A GEOTECHNICAL ENGINEER FROM GEOSOLUTIONS. IT IS RECOMMENDED TO KEEP GEOSOLUTIONS ON SITE DURING TANK SITE EXCAVATION.

BUILDING NOTES:
 1. STANDARD 20' X 25' PRE-ENGINEERED METAL BUILDING AND FOUNDATION SHALL BE PROVIDED BY VARCO PRUDEN, BUTLER MANUFACTURING, BROOKS RAMSON ASSOC., OR APPROVED EQUAL.
 2. BUILDING PAD, CONDUIT, PIPE STUB-UPS, & CHLORINATION EQUIPMENT SHALL BE PROVIDED AS SHOWN. BUILDING AND FILTRATION EQUIPMENT MAY BE PROVIDED IN FUTURE.
 3. CONTRACTOR SHALL SUBMIT BUILDING CONDUIT PLAN TO ENGINEER OF RECORD PRIOR TO FOUNDATION CONSTRUCTION.

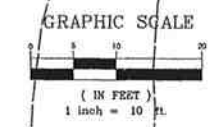
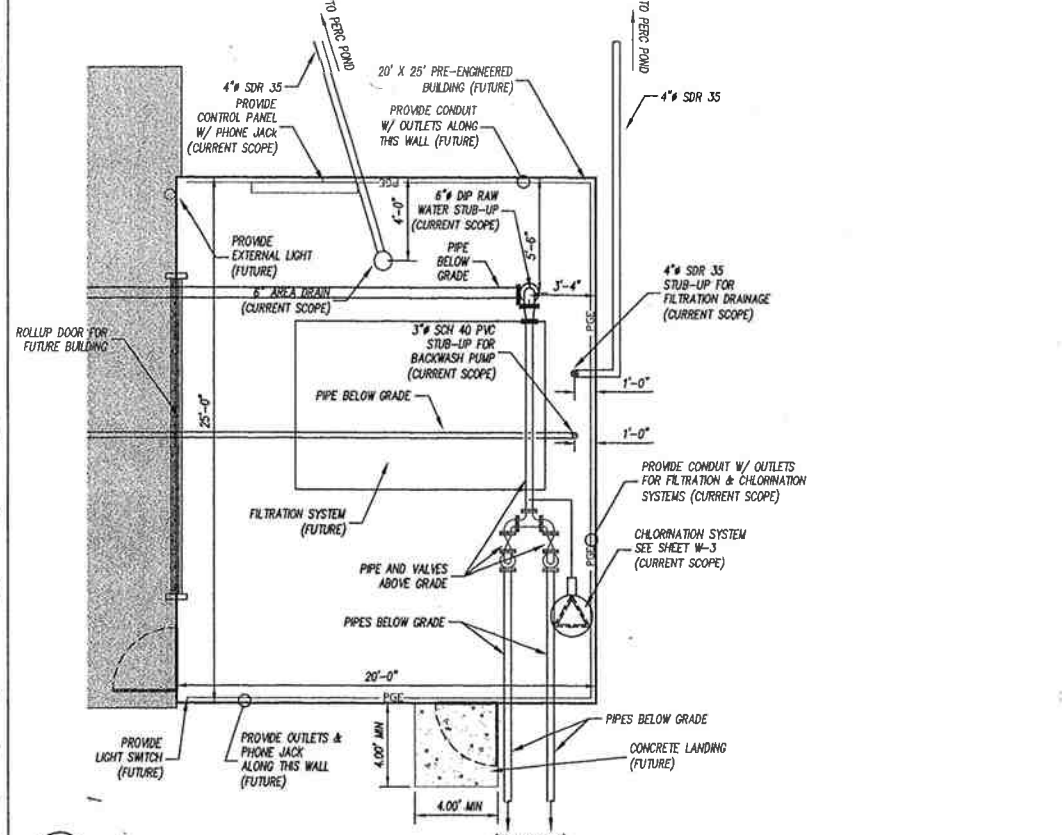

These plans and specifications, and the ideas and designs incorporated herein, are instruments of service prepared for the construction of work shown hereon and shall not be used in whole or in part for any other project without written authority of Wallace Group, a California Corporation.

Copyright © 2006 Wallace Group, a California Corporation. All rights reserved. Copies of this drawing shall have this notice.

4115 BRAD STREET, SUITE B-5, SAN LUIS OBISPO, CA 95041 WALLACE GROUP			
TRACT 2408 - BIDDLE RANCH EAST TANK SITE GRADING PLAN			
Design/Drawn:	County:	Development Services Engineer	Date:
MWSLS	San Luis Obispo	Matthew J. Wilkes	01-08-07
Job No.:	County W.O. No.:	Project Engineer	Date:
S014-0001	201R110299	Matthew J. Wilkes	01-08-07
California Coordinates:	225200	804450	SHEET W-5 OF 5

Exhibit D: Sampling Station Plan

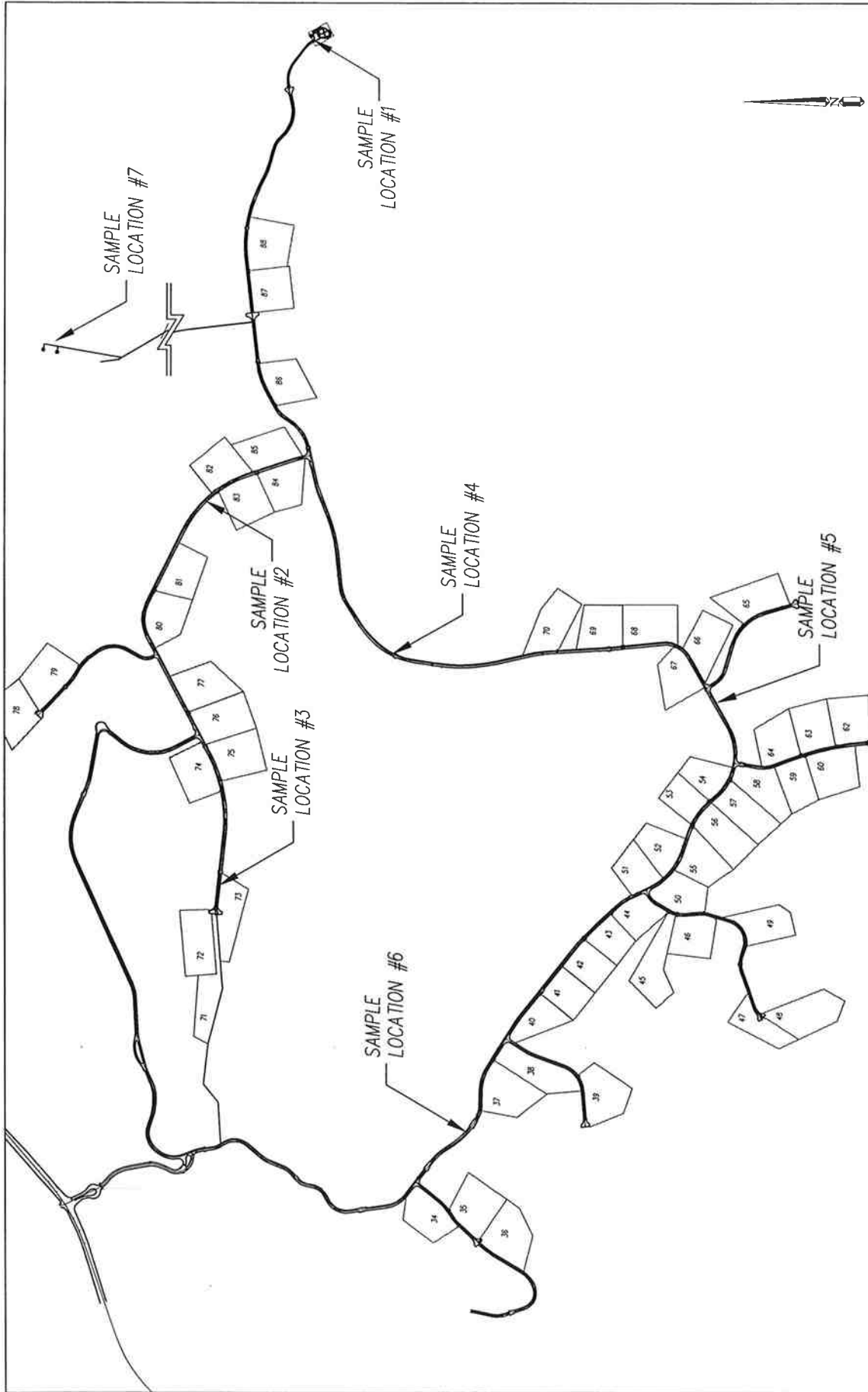

JOB No. : S014-0001
 DRAWING : BACT. SAMPLING
 DRAWN BY: SLS
 DATE : 03-21-06
 SCALE : 1"=1000'

**BIDDLE RANCH EAST CLUSTER
 TRACT 2408
 BACTERIOLOGICAL SAMPLING PLAN**

1330 ARNOLD DRIVE, SUITE 249
 MARTINEZ, CALIFORNIA 94553
 T 925 228-5801
 F 925 228-5804
 www.wallacegroup.us



WALLACE GROUP

Exhibit E: Domestic Water Supply Permit from San Luis Obispo County
Health Department

SAN LUIS OBISPO COUNTY HEALTH AGENCY



PUBLIC HEALTH

Environmental Health Services Division

2156 Sierra Way ▪ P.O. Box 1489
San Luis Obispo, California 93406
805-781-5544 ▪ FAX 805-781-4211

Jeff Hamm

Health Agency Director

Craig McMillan, M.D., M.P.H.

County Health Officer

Curtis A Batson, R.E.H.S.

Director of Environmental Health

June 25, 2008

Robert S. Miller, P.E.
Wallace Group
612 Clarion Court
San Luis Obispo, CA 93401

System No: 4000815 (Las Ventanas Ranch Mutual Benefit Water Company)

Dear Mr. Miller:

The County of San Luis Obispo has considered the application of the Las Ventanas Ranch Mutual Benefit Water Company dated June 18, 2008 and has issued a domestic water supply permit. The permit is enclosed. The Las Ventanas Ranch water system will need to advise us in writing within 30 days if you do not agree to the permit and its conditions.

If you have any questions regarding this permit, please contact me at (805) 788-2049.

Sincerely,

BRADLEY PRIOR, R.E.H.S.
Environmental Health Specialist II

STATE OF CALIFORNIA

DOMESTIC WATER SUPPLY PERMIT

Issued To

**LAS VENTANAS RANCH MUTUAL BENEFIT
WATER COMPANY**

Public Water System No. 4000815

By

County of San Luis Obispo Environmental Health Services

DATE: June 25, 2008



WHEREAS:

1. The **Las Ventanas Ranch Mutual Benefit Water Company** submitted an application dated **June 18, 2008** to **County of San Luis Obispo Environmental Health Services** to operate a public water system. The application was submitted in accordance with California Health and Safety Code, Section 116525.
2. This public water system is known as the **Las Ventanas Ranch Mutual Benefit Water Company** whose headquarters mailing address is located at **612 Clarion Court, San Luis Obispo, CA 93402**.
3. The legal owner of the **Las Ventanas Ranch Mutual Benefit Water Company** water system is **Las Ventanas Ranch Mutual Benefit Water Company**. **Las Ventanas Ranch Mutual Benefit Water Company**, therefore, is responsible for compliance with all statutory and regulatory drinking water requirements and the conditions set forth in this permit.
4. The public water system for which the permit application has been submitted is as described briefly below (a more detailed description of the permitted system is described in the attached Permit Report):

Las Ventanas Ranch Mutual Benefit Water Company is a community system serving 55 residential service connections with approximately 165 consumers. The system has two active wells, each of which produces 110 gallons per minute; total production is 220 gallons per minute.

And WHEREAS:

1. **Las Ventanas Ranch Mutual Benefit Water Company** has submitted all of the required information relating to the existing operation of the **Las Ventanas Ranch Water System**.
2. The **County of San Luis Obispo Environmental Health Services** has evaluated all of the information submitted by the **Las Ventanas Ranch Mutual Benefit Water Company** and has conducted a physical investigation of the existing **Las Ventanas Ranch Water System**.
3. The **County of San Luis Obispo Environmental Health Services** has been delegated authority to issue domestic water supply permits pursuant to Health and Safety Code Section 116540.

THEREFORE: The **County of San Luis Obispo Environmental Health Services** has determined the following:

1. The **Las Ventanas Ranch Water System** meets the criteria for and is hereby classified as a **community** water system.
2. The applicant has demonstrated that the existing **Las Ventanas Ranch Water System** has sufficient source capacity to serve the anticipated water demand for at least **10** years.
3. The design of the proposed water system complies with the Water Works Standards and all applicable regulations.
4. The applicant has demonstrated adequate technical, managerial, and financial capacity to operate reliably the proposed water system.
5. Provided the following conditions are complied with, the **Las Ventanas Ranch Water System** should be capable of providing water to consumers that is pure, wholesome, and potable and in compliance with statutory and regulatory drinking water requirements at all times.

THE LAS VENTANAS RANCH MUTUAL BENEFIT WATER COMPANY IS HEREBY ISSUED THIS DOMESTIC WATER SUPPLY PERMIT TO OPERATE THE LAS VENTANAS RANCH WATER SYSTEM.

The **Las Ventanas Ranch Water System** shall comply with the following permit conditions:

California Safe Drinking Water Act

1. The **Las Ventanas Ranch Mutual Benefit Water Company** shall comply with all State laws applicable to public water systems, including, but not limited to the Health and Safety Code and any regulations, standards, or orders adopted there under.

Operator Certification Program

2. The distribution system shall be operated by personnel who have been certified in accordance with the Regulations Relating to Certification of Distribution System, California Code of Regulations, Title 22. The **Las Ventanas Ranch Mutual Benefit Water Company** will need a D1 certified operator for the operation of the water system.

Cross-Connection Control Program

3. The **Las Ventanas Ranch Mutual Benefit Water Company** shall comply with Title 17 of the California Code of Regulations (CCR), to prevent the water system and treatment facilities from being contaminated from possible cross-connections. The **Las Ventanas Ranch Mutual Benefit Water Company** shall maintain a program for the protection of the domestic water system against backflow from premises having dual or unsafe water systems in accordance with Title 17. All backflow prevention devices shall be tested annually.

Approved Sources

4. The only sources approved for potable water supply are listed below. The Las Ventanas Ranch Mutual Benefit Water Company shall provide reliable chlorination treatment for the distribution system at all times and maintain a chlorine residual of minimum of 0.5-1.0 mg/l at the storage tanks.

Source	Status	PS Code
Well A	Active	4000815-001
Well B	Active	4000815-002

5. No changes, additions, or modifications shall be made to the sources or treatment mentioned in Conditions No. 4 unless an amended water permit has first been obtained from Environmental Health Services.

Water Quality Monitoring

6. The existing sources shall continued to be analyzed for, and prior to using a new or inactive well for domestic purposes, bacteriological and complete chemical analysis of the water produced, including secondary standards and inorganic chemicals shall be submitted to Environmental Health Services, to determine compliance with the California Drinking Water Quality Standards. The analyses shall be made by an approved state certified laboratory and shall be submitted electronically on state approved forms.
7. The **Las Ventanas Ranch Mutual Benefit Water Company** shall analyze at least one sample from its distribution system monthly for bacteriological quality in accordance with its approved bacteriological sample-siting plan. A bacteriological analyses report shall be submitted to this office by the tenth of the month following sampling.
8. The **Las Ventanas Ranch Mutual Benefit Water Company** shall contact this office by phone concerning any acute violation or the occurrence of a hazardous situation. MCL violations will require public notification and corrective action.

Las Ventanas Ranch Mutual Benefit Water Company
June 25, 2008

This permit supersedes all previous domestic water supply permits issued for this public water system and shall remain in effect unless and until it is amended, revised, reissued, or declared to be null and void by the **County of San Luis Obispo Environmental Health Services**. This permit is non-transferable. Should the **Las Ventanas Ranch Mutual Benefit Water Company** Water System undergo a change of ownership, the new owner must apply for and receive a new domestic water supply permit.

Any change in the source of water for the water system, any modification of the method of treatment as described in the Permit Report, or any addition of distribution system storage reservoirs shall not be made unless an application for such change is submitted to the **County of San Luis Obispo Environmental Health Services**.

This permit shall be effective as of the date shown below.

FOR COUNTY OF SAN LUIS OBISPO ENVIRONMENTAL HEALTH SERVICES



Curtis Batson
Director, Environmental Health Services

Dated: June 25, 2008

**LAS VENTANAS RANCH WATER SYSTEM
SYSTEM # 4000815
WATER QUALITY MONITORING SCHEDULE**

WELL A (4000815-001) Source Code

<u>Chemical</u>	<u>Frequency</u>	<u>Last Completed</u>	<u>Due Again</u>
Nitrate	Annually	03/2006	07/2008
Inorganic Chemicals (IOCs) Asbestos-waived	Every 3 years	03/2006	03/2009
Nitrite	Every 3 years	03/2006	03/2009
Secondary Standards Thiobencarb-waived	Every 3 years	03/2006	03/2009
Volatile Organic Chemicals (VOCs)	Every 3-6 years	03/2006	03/2009
Synthetic Organic Chemicals (SOCs)			
Atrazine	Once	03/2006	Completed
Simazine	Once	03/2006	Completed
Radioactivity (Gross Alpha)	Initially quarterly for a year, then every 3-9 years	03/2006	DUE NOW
Lead & Copper **	Once every 6 months for a year, annually for 2 years, then every 3 years		
Total Trihalomethanes/Haloacetic Acids (TTHM/HAA5)			
Perchlorate			DUE NOW

* Monitoring waiver extended

** Samples to be collected at the consumers tap. All efforts should be made to use the same collection sites during all sampling periods. Results to be submitted with form 141-A

**LAS VENTANAS RANCH WATER SYSTEM
SYSTEM # 4000815
WATER QUALITY MONITORING SCHEDULE**

WELL B (4000815-002) Source Code

<u>Chemical</u>	<u>Frequency</u>	<u>Last Completed</u>	<u>Due Again</u>
Nitrate	Annually	07/2005	07/2008
Inorganic Chemicals (IOCs) Asbestos-waived	Every 3 years	07/2005	07/2008
Nitrite	Every 3 years	07/2005	07/2008
Secondary Standards Thiobencarb-waived	Every 3 years	07/2005	07/2008
Volatile Organic Chemicals (VOCs)	Every 3-6 years	03/2006	03/2009
Synthetic Organic Chemicals (SOCs)			
Atrazine	Once	03/2006	Completed
Simazine	Once	03/2006	Completed
Radioactivity (Gross Alpha)	Initially quarterly for a year, then every 3-9 years	03/2006	DUE NOW
Lead & Copper **	Once every 6 months for a year, annually for 2 years, then every 3 years		
Total Trihalomethanes/Haloacetic Acids (TTHM/HAA5)			
Perchlorate			DUE NOW

* Monitoring waiver extended

** Samples to be collected at the consumers tap. All efforts should be made to use the same collection sites during all sampling periods. Results to be submitted with form 141-A